

TABOURET



MATÉRIAUX DU GISEMENT AVANT DÉCOUPE

Baguette chinoise



Tasseau de bois



Tube en aluminium



Plaque polystyrène



Carton bois



Carton bois



- clou
- vis
- Trombone
- Fil de fer
- Ficelle
- Scotch
- Scie à main
- colle
- Cutter
- Ciseau
- Pince
- Clou
- Fil de pêche

CROQUIS DE CONCEPTION

RECHERCHE DE FORME :

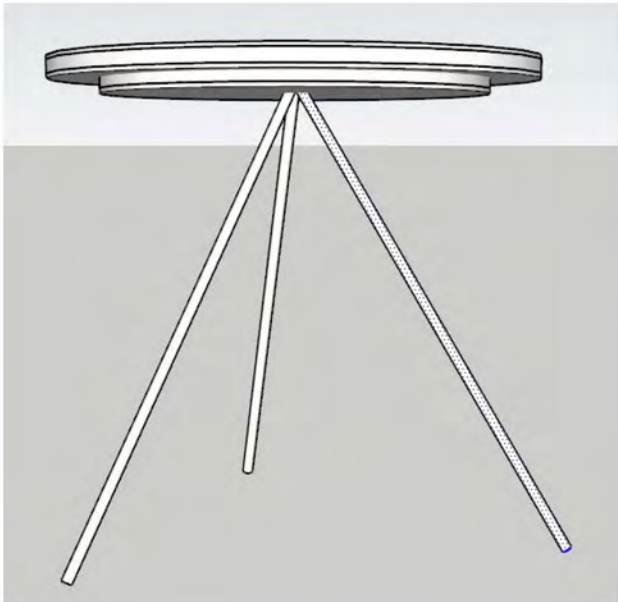
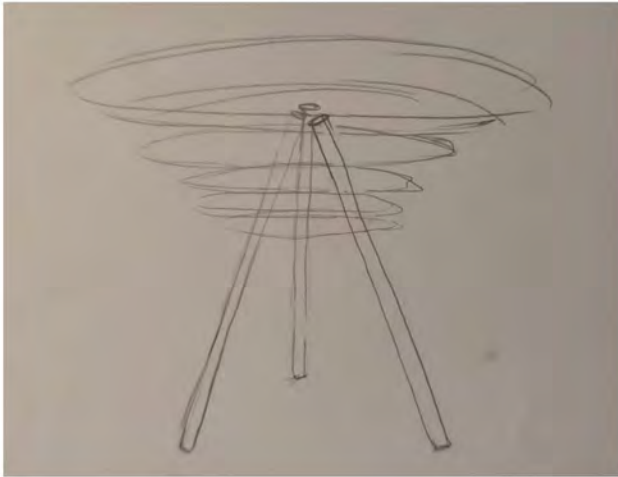

CROQUIS FINAL



CROQUIS DE DÉTAILS

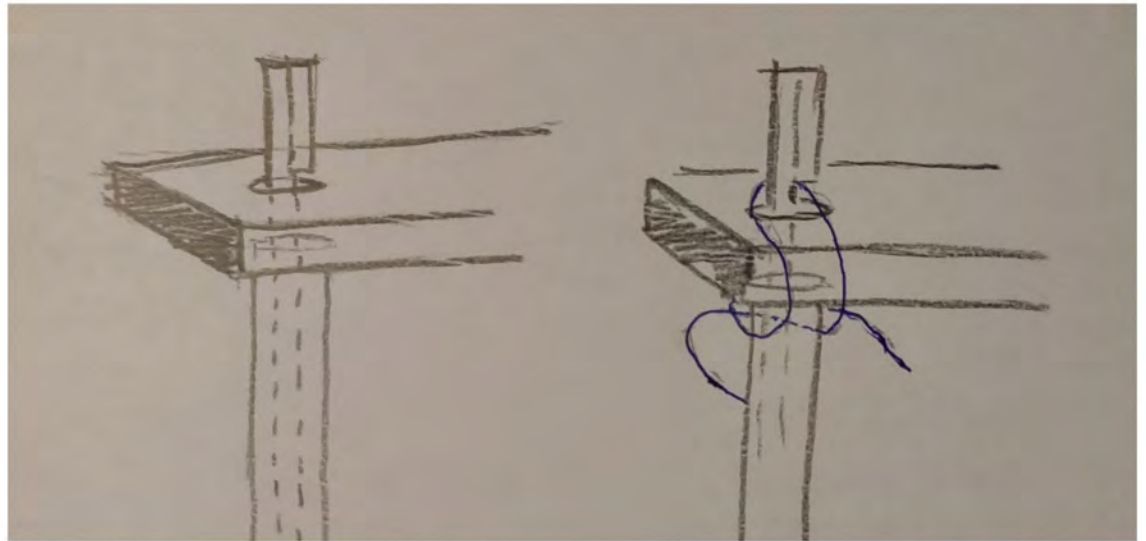
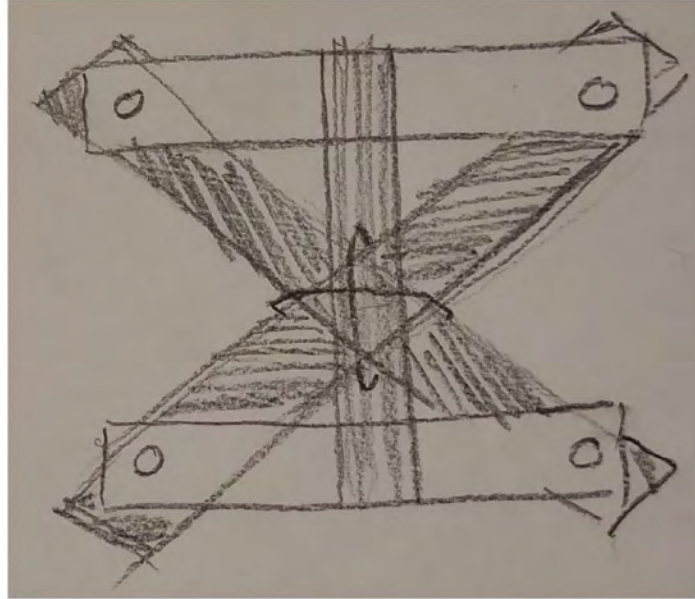
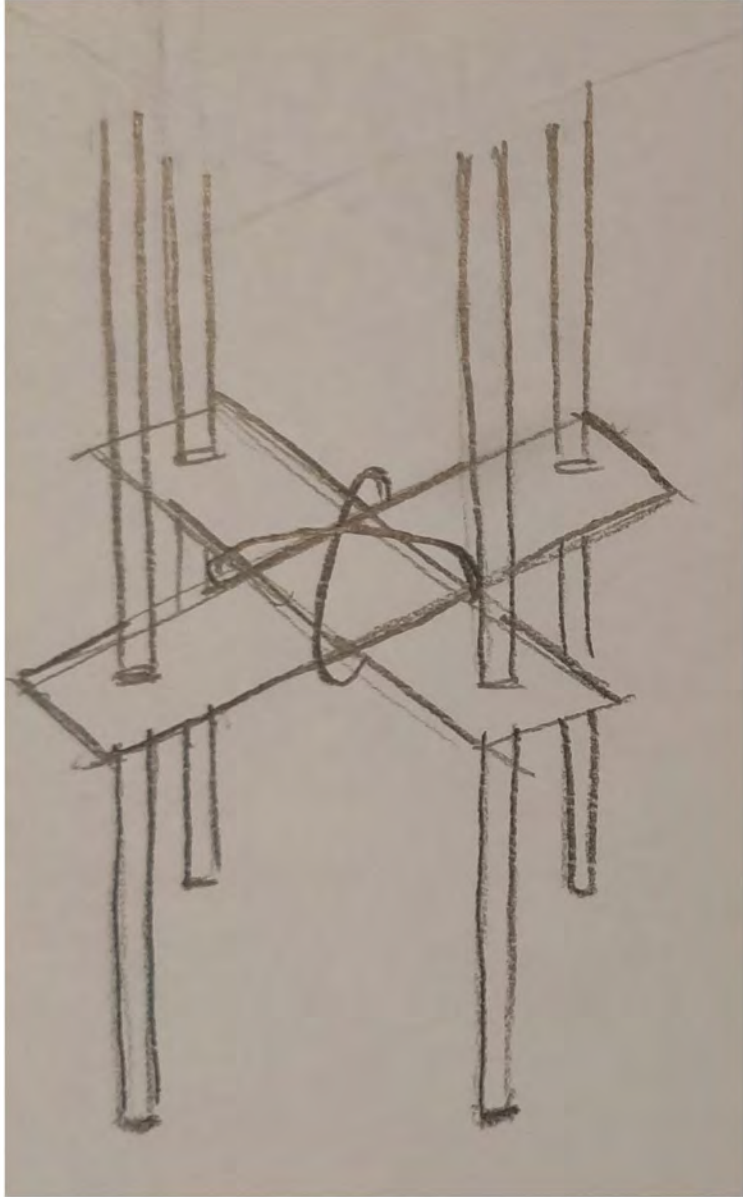

PHOTOS DES PIÈCES AVANT MONTAGE

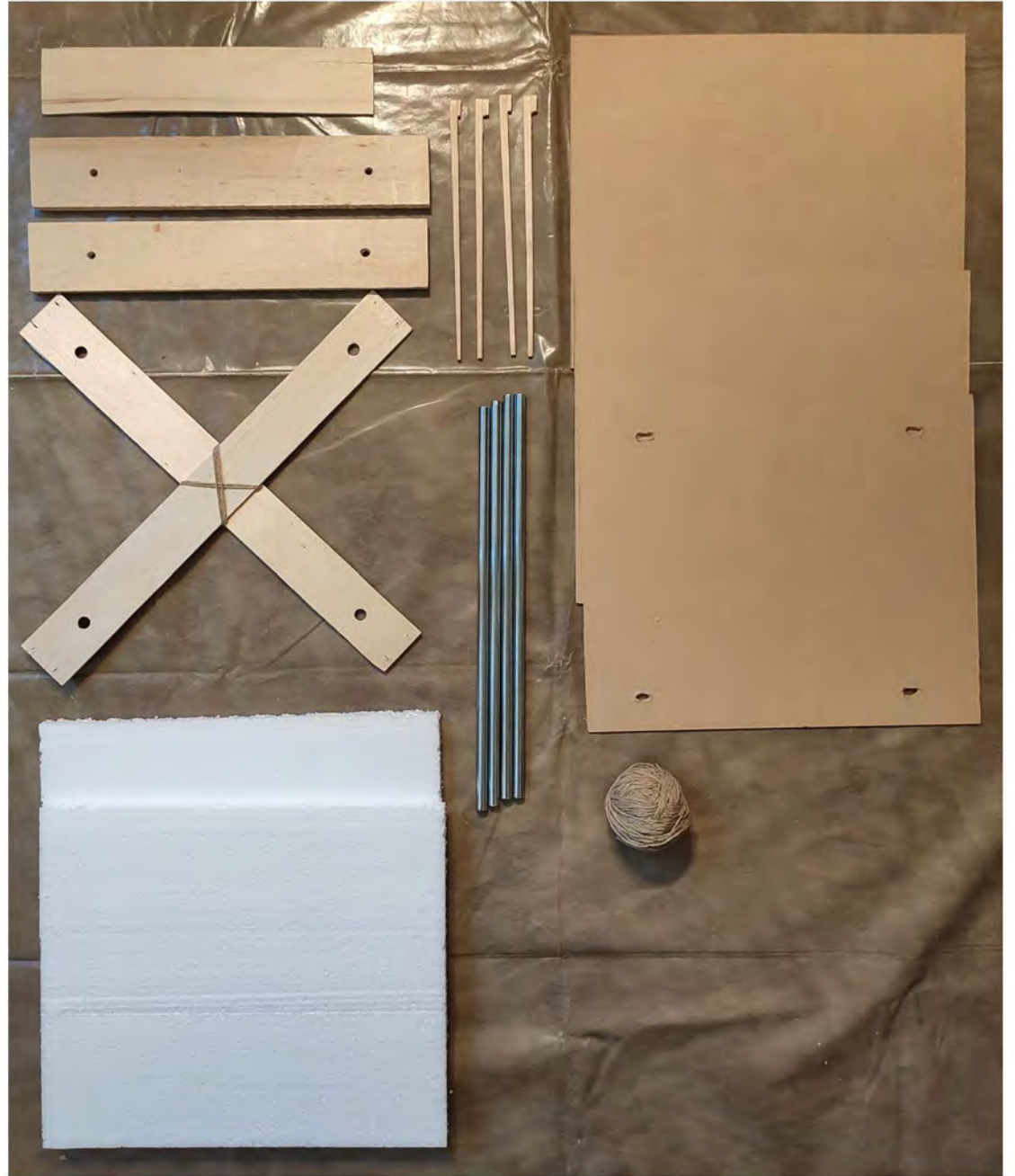

PHOTOS DE LA CONCEPTION



PHOTOS DE DÉTAILS







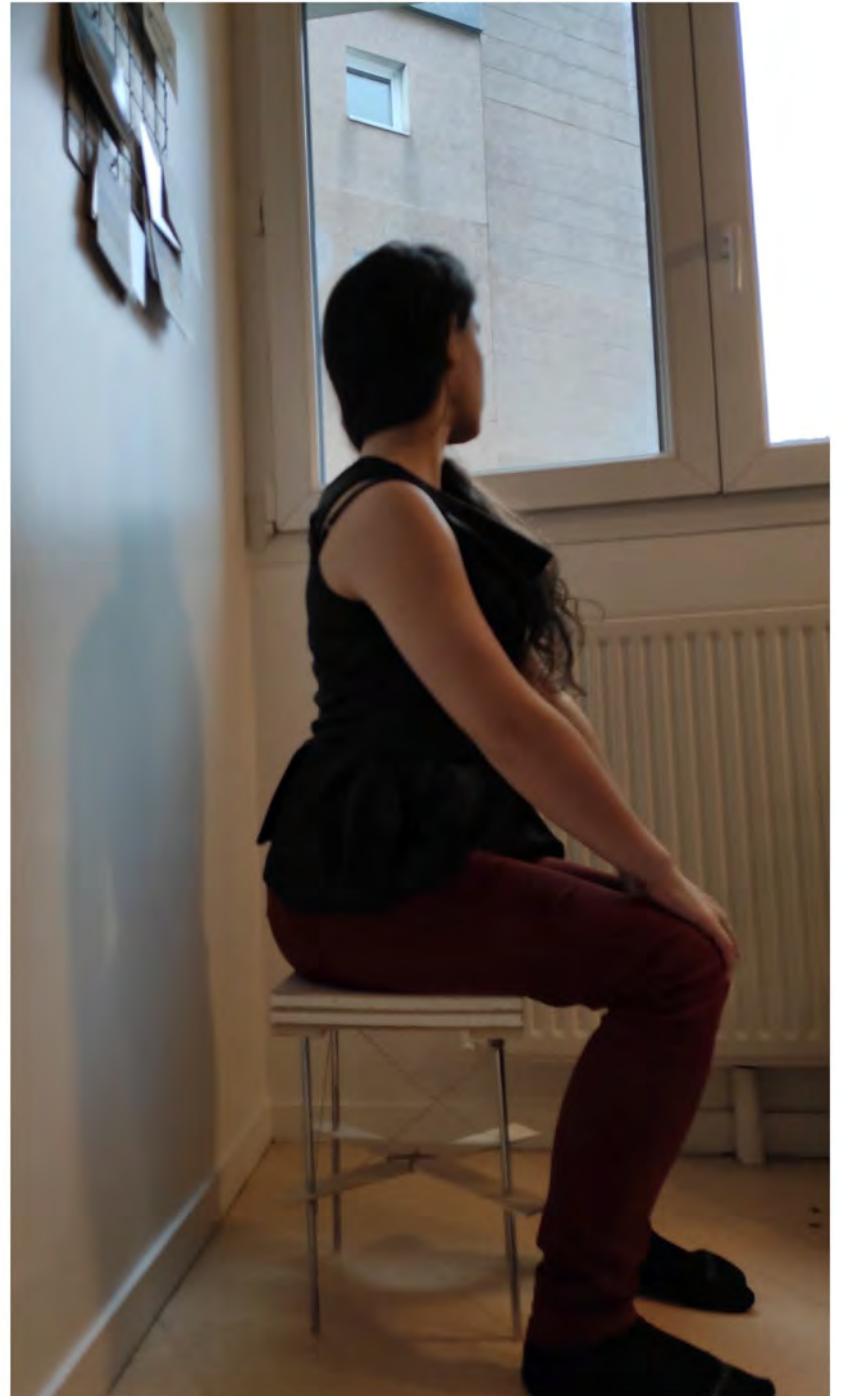

ETAGÈRES SUSPENDUES



MATÉRIAUX ISSUS DU TABOURET AVANT DÉCOUPE



- 4 Tasseaux perforés
- 1 petit tasseau
- 4 baguettes chinoise
- 4 tubes en aluminium
- 2 plaques de polystyrène
- 3 plaques de carton bois
- Ficelle
- Scotch noir

CROQUIS DE CONCEPTION

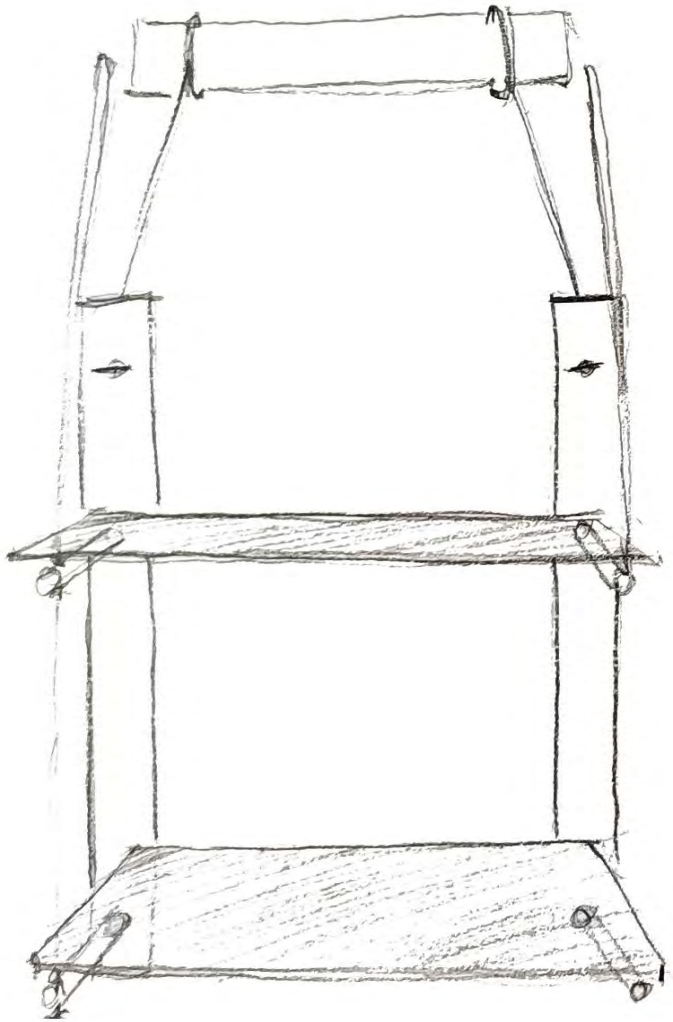

VUE DE FACE

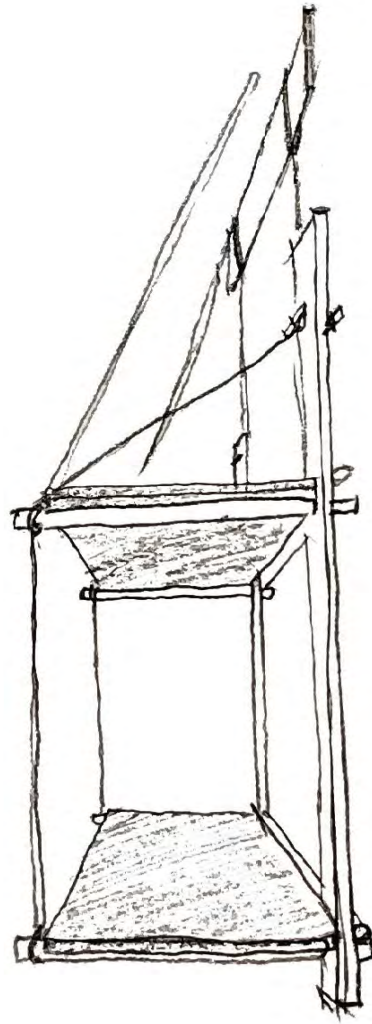

VUE DE CÔTÉ

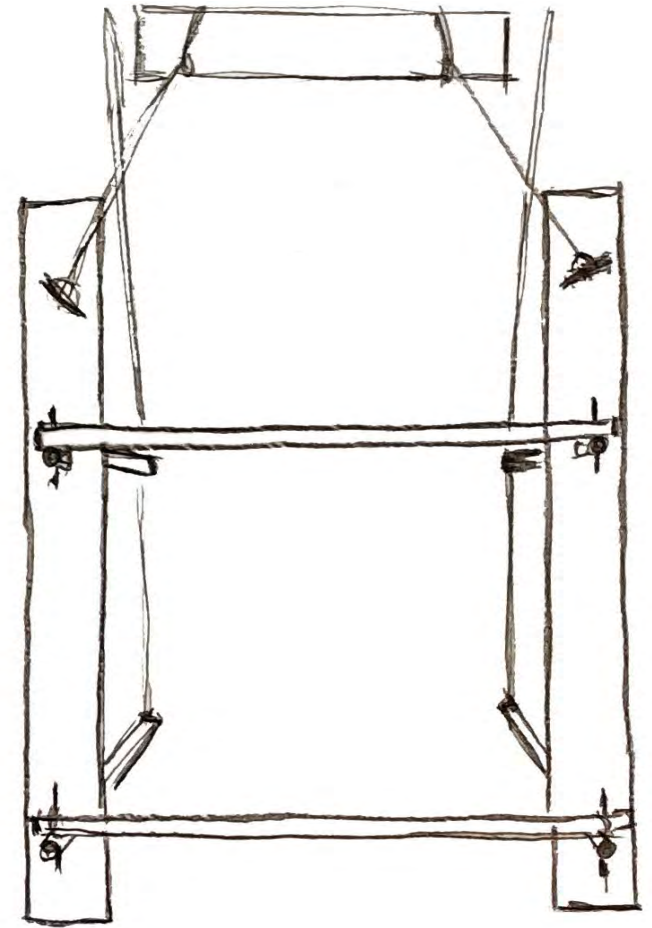

VUE DE DERRIÈRE

PHOTOS DES PIÈCES AVANT MONTAGE

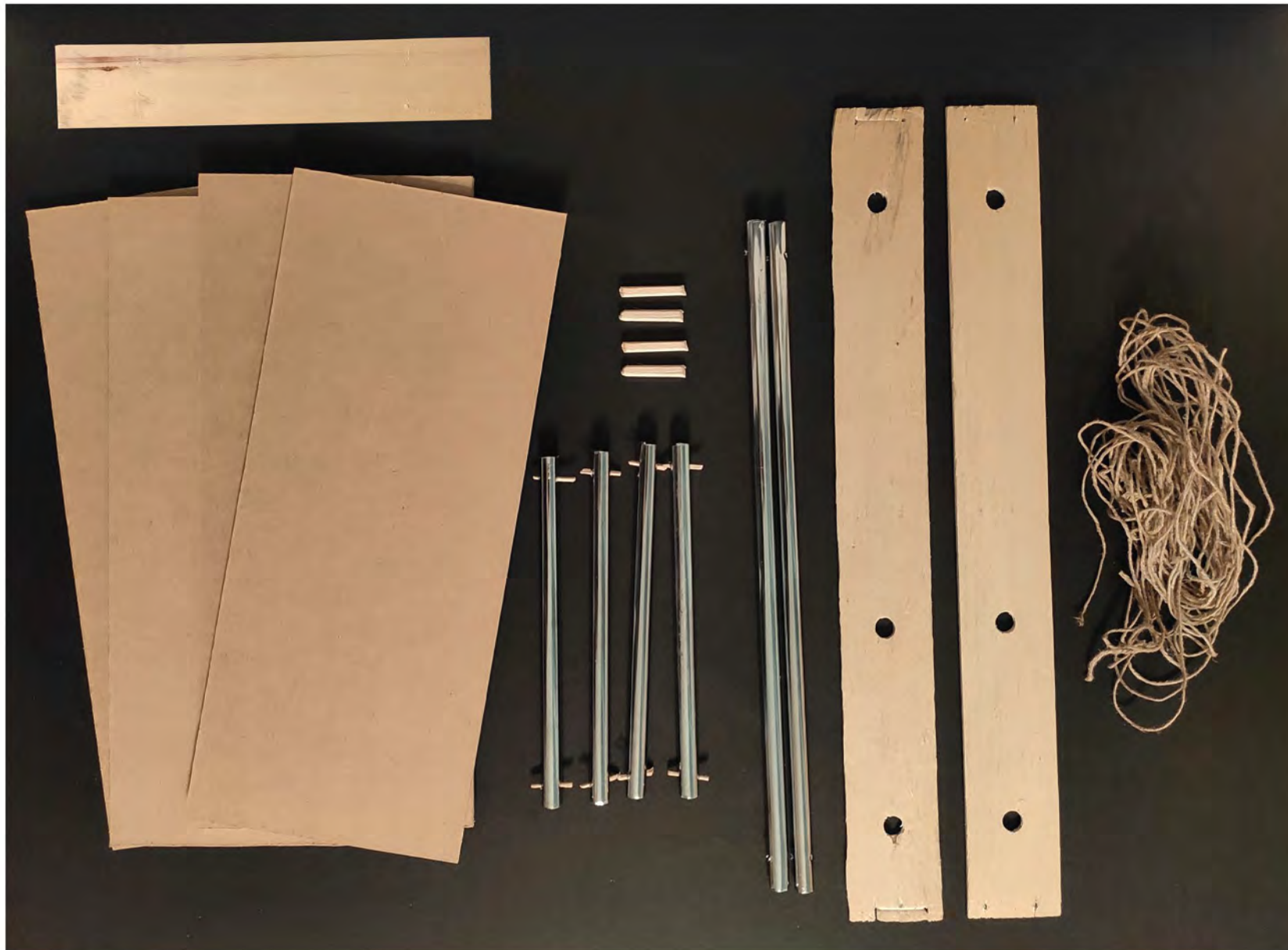

- 2 Tasseaux perforés
- 1 petit tasseau
- Morceaux de baguettes chinoise
- 2 tubes en aluminium 32cm
- 4 tubes en aluminium 16cm
- Ficelle
- Scotch noir

PHOTOS DE LA CONCEPTION - VUE DE DERRIÈRE

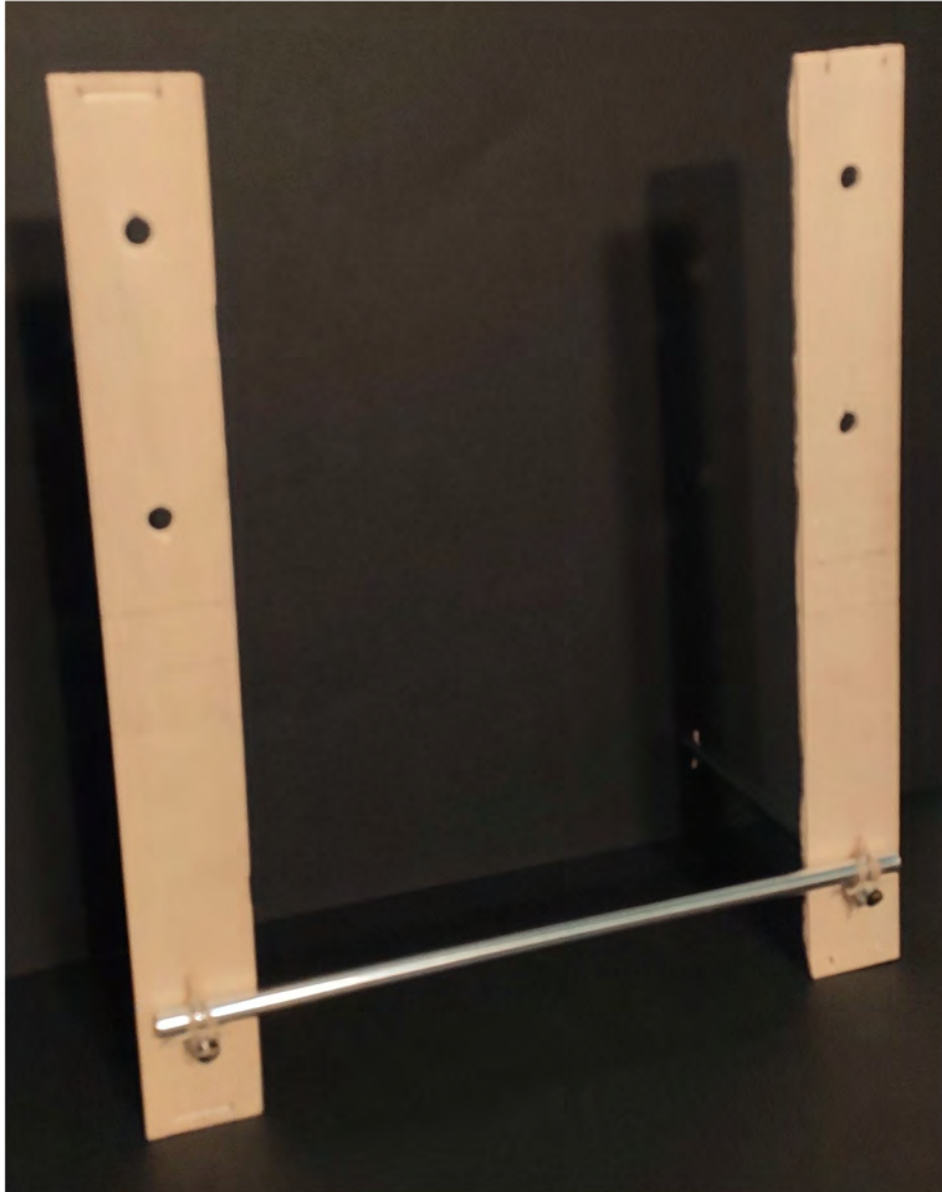

PHOTOS DE DÉTAILS - ASSEMBLAGE DES TUBES SITUÉ À L'ARRIÈRE

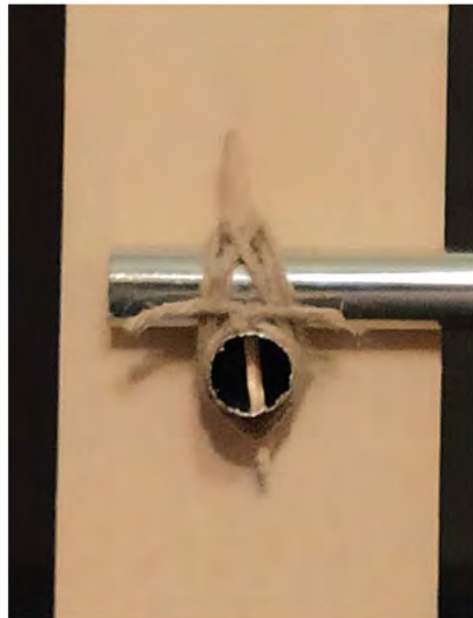
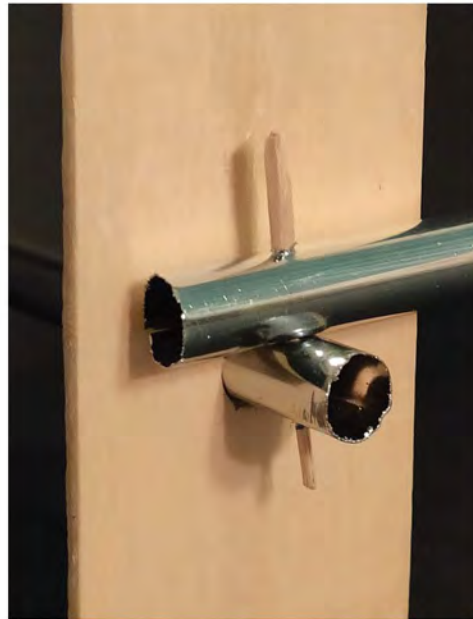
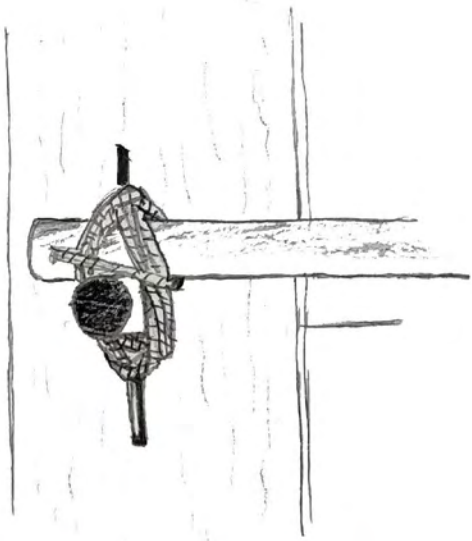

CROQUIS DE DÉTAILS

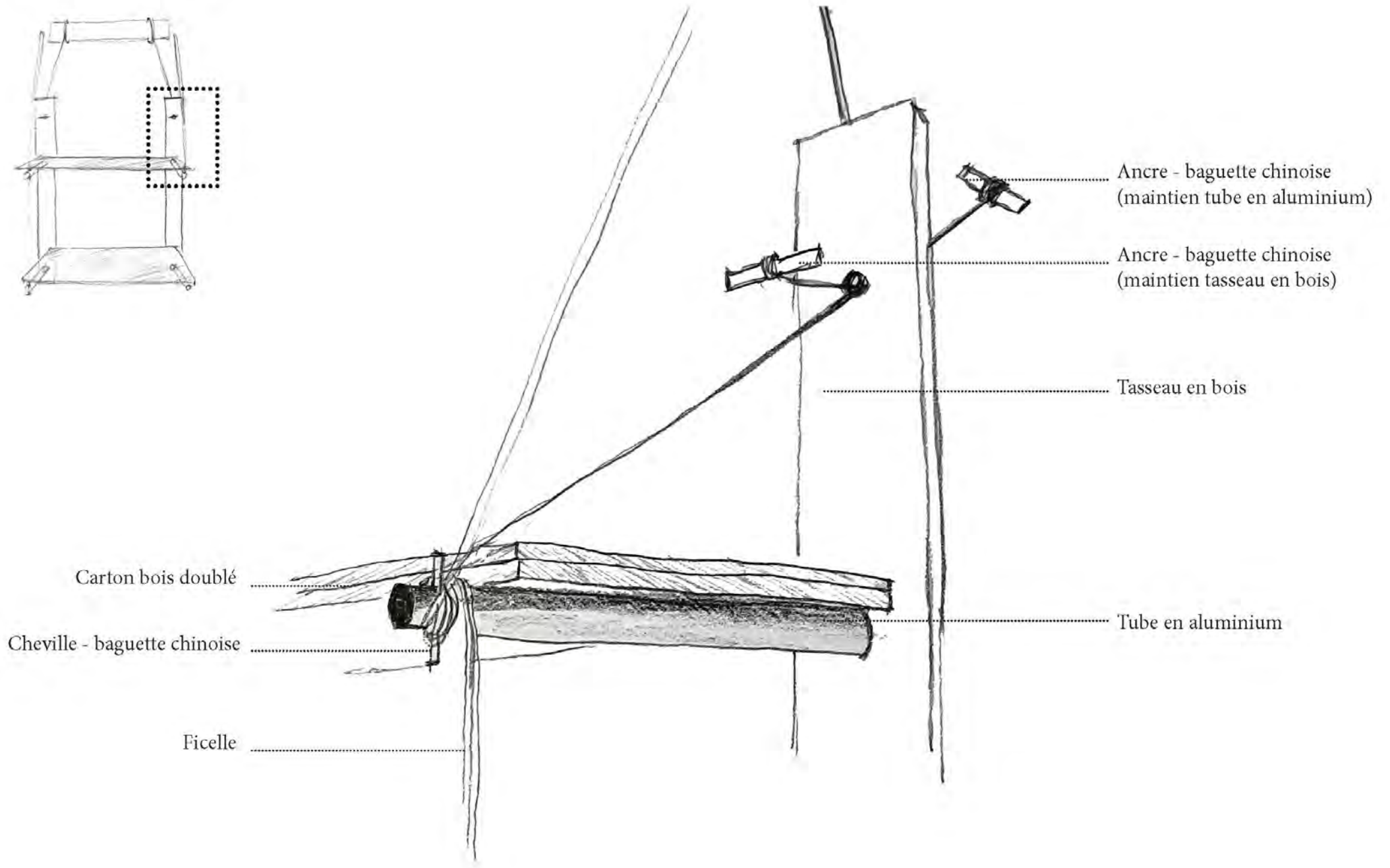
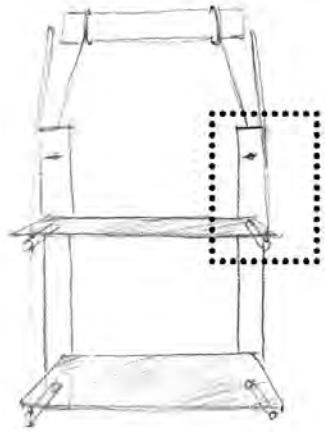

PHOTOS DE LA CONCEPTION - ÉTAGÈRES



PHOTOS DE LA CONCEPTION - ÉTAGÈRES

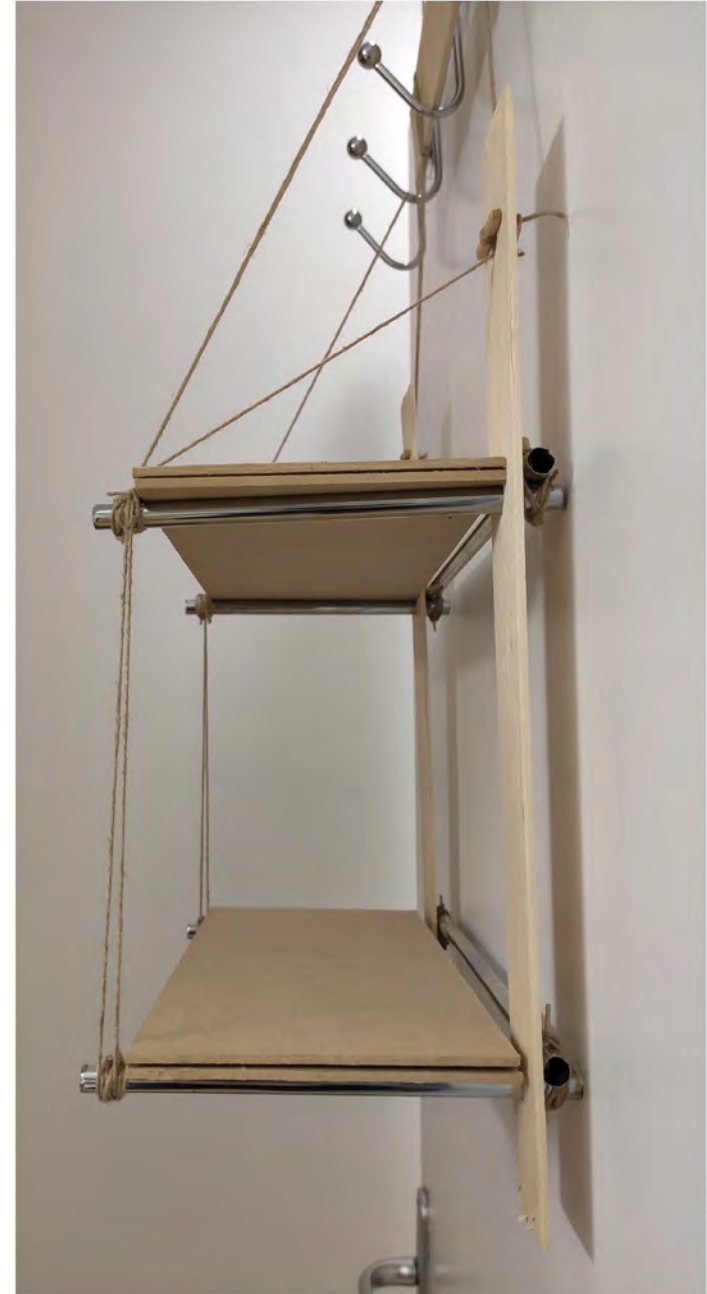

PHOTOS EN UTILISATION



LAMPE



MATÉRIAUX ISSUS DE L'ÉTAGÈRE SUSPENDUE AVANT DÉCOUPE ET EMBALLAGES DE MÉDICAMENT (GISEMENT INITIAL)



- 2 Tasseaux perforés
- 1 petit tasseau
- Chevilles différentes taille (morceaux de baguettes chinoise)
- 2 tubes en aluminium 32cm
- 4 tubes en aluminium 16cm
- Ficelles
- Scotch noir
- Emballages de médicaments



CROQUIS DE CONCEPTION

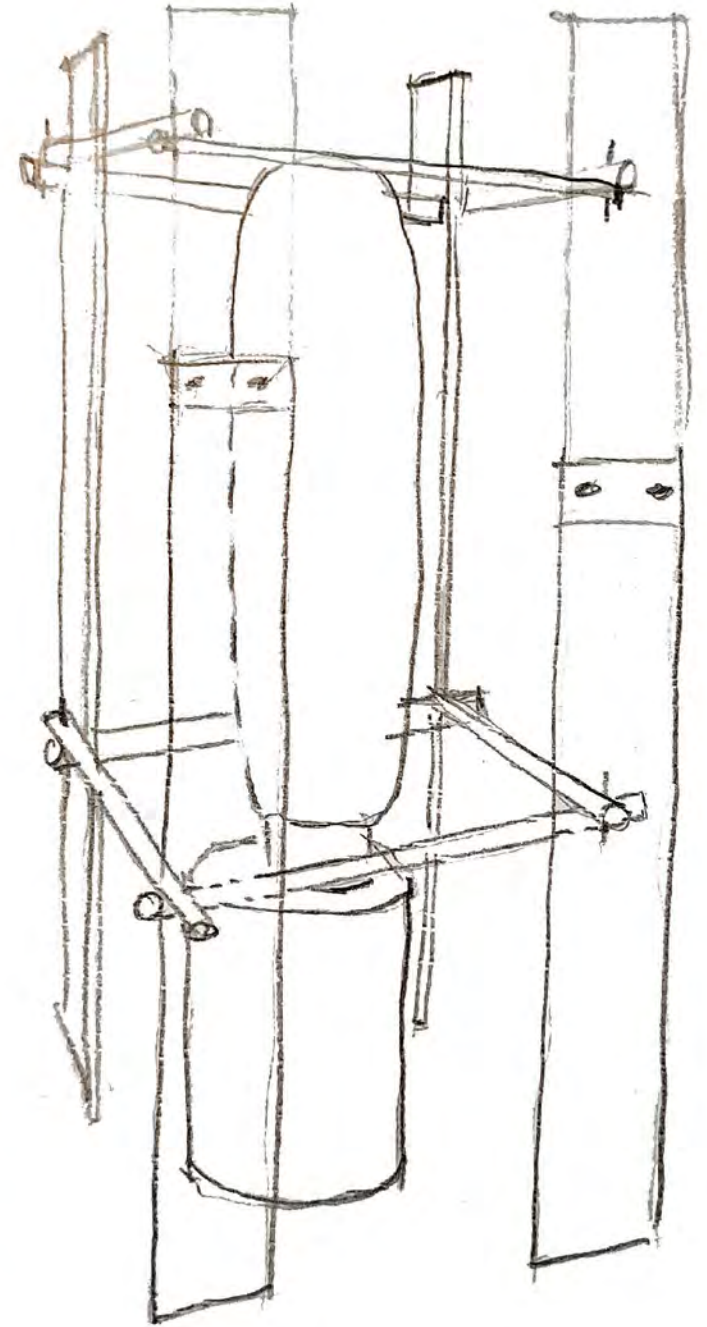
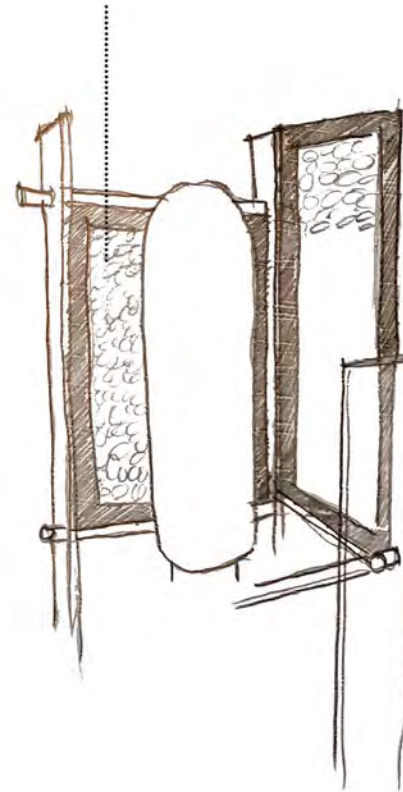
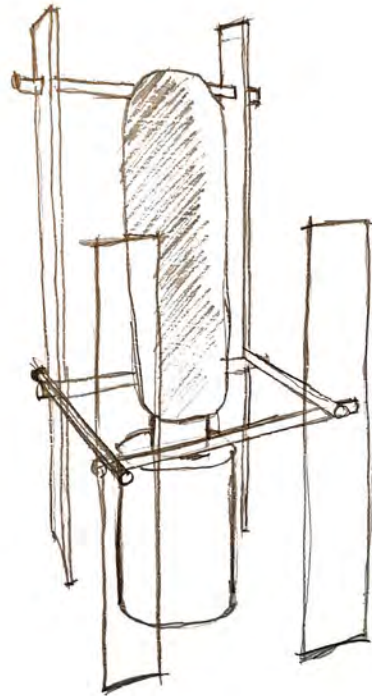

PHOTOS DES PIÈCES AVANT MONTAGE



- 2 Tasseaux perforés
- 4 Chutes de carton bois perforé
- Chevilles
- 8 tubes en aluminium 16cm
- Ficelles
- Emballages de médicaments
- Feutres
- Agrafeuse
- Scotch noir

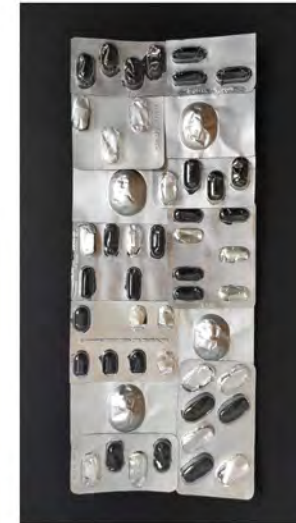
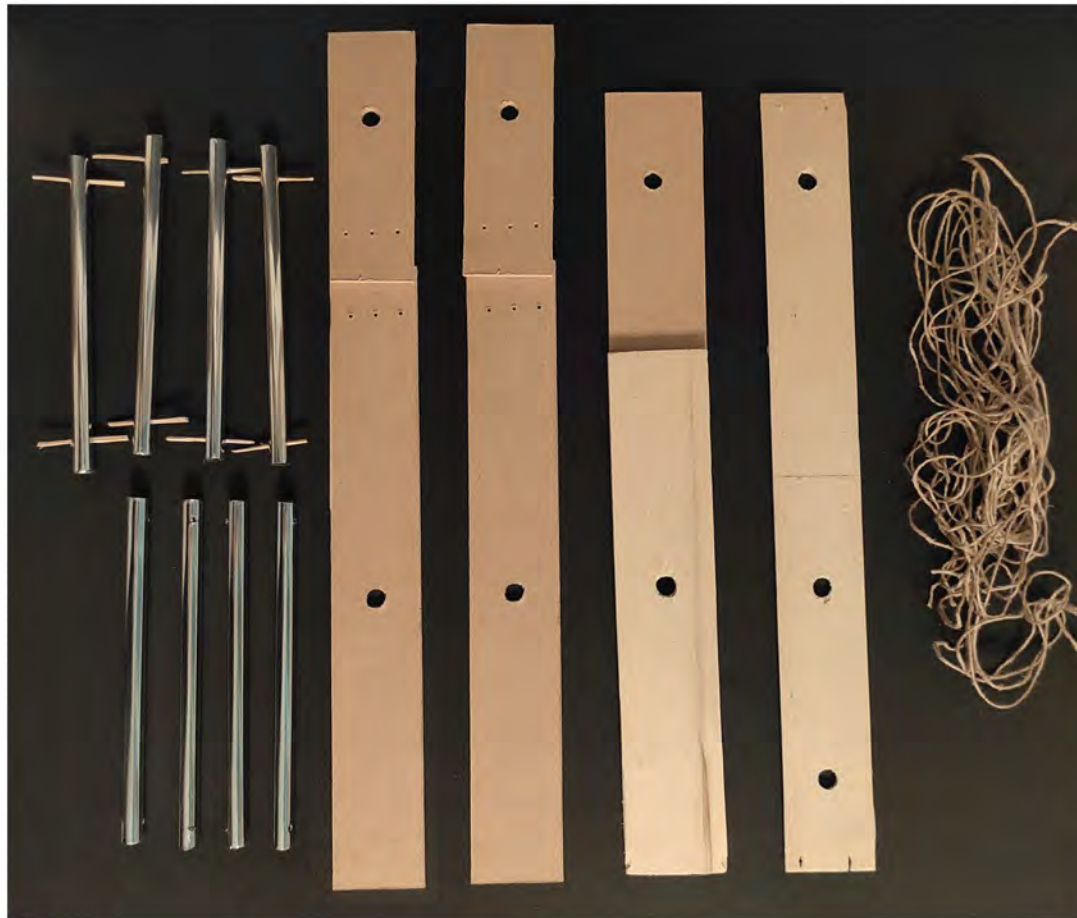

PHOTOS DE LA CONCEPTION - CONSTRUCTION DE LA STRUCTURE

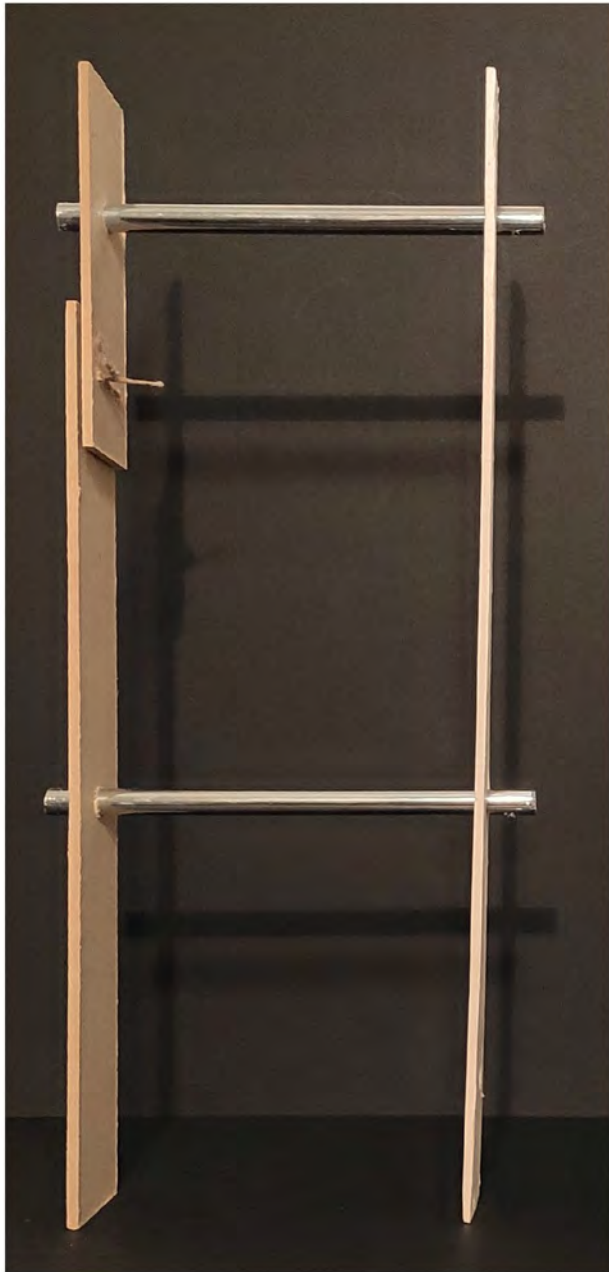

PHOTOS DE DÉTAILS - STRUCTURE FINI



PHOTOS DE DÉTAILS - ASSEMBLAGE DES TUBES

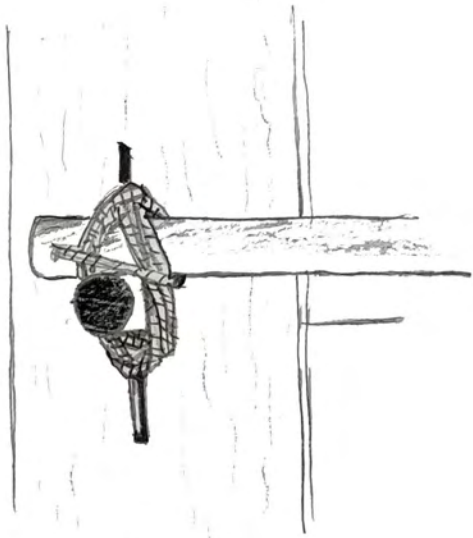

PHOTOS DE DÉTAILS - ASSEMBLAGE DES CHUTES DE CARTON BOIS

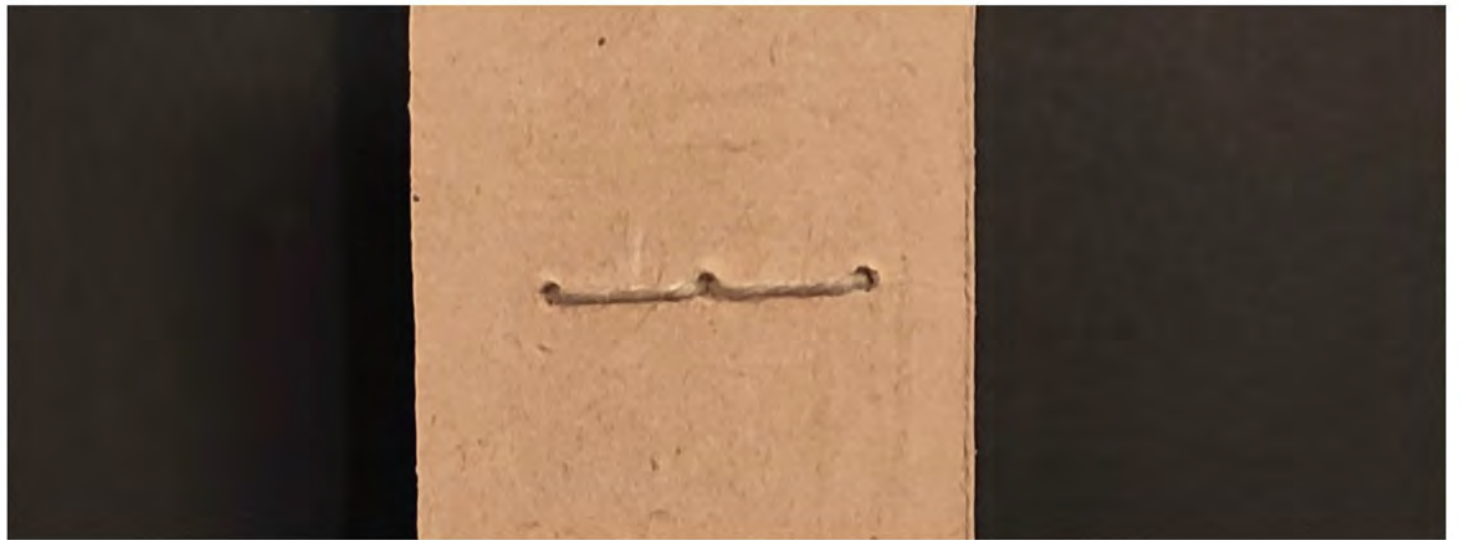
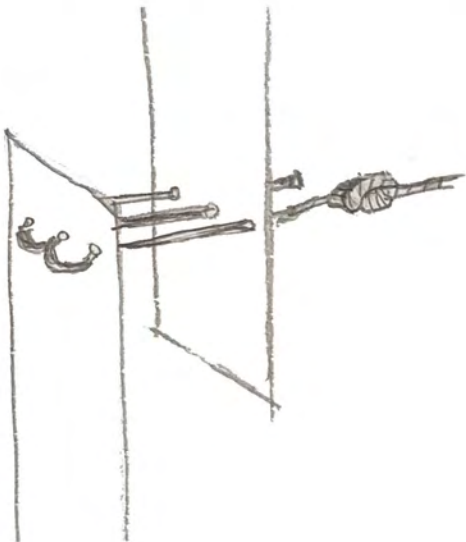

PHOTOS DE LA CONCEPTION - TRESSAGE DE LA FICELLE



PHOTOS DE LA CONCEPTION - FACE



PHOTOS EN UTILISATION



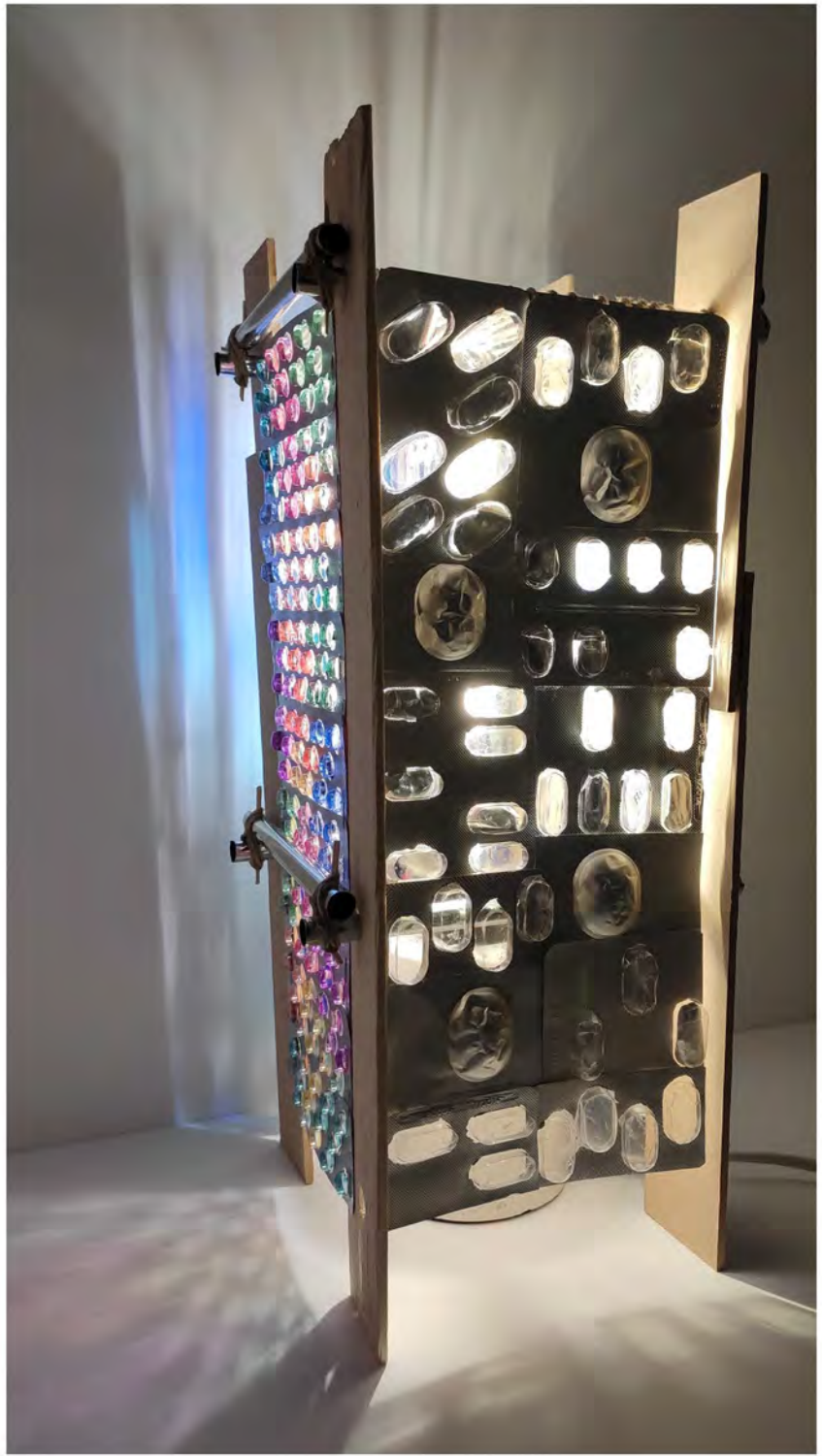

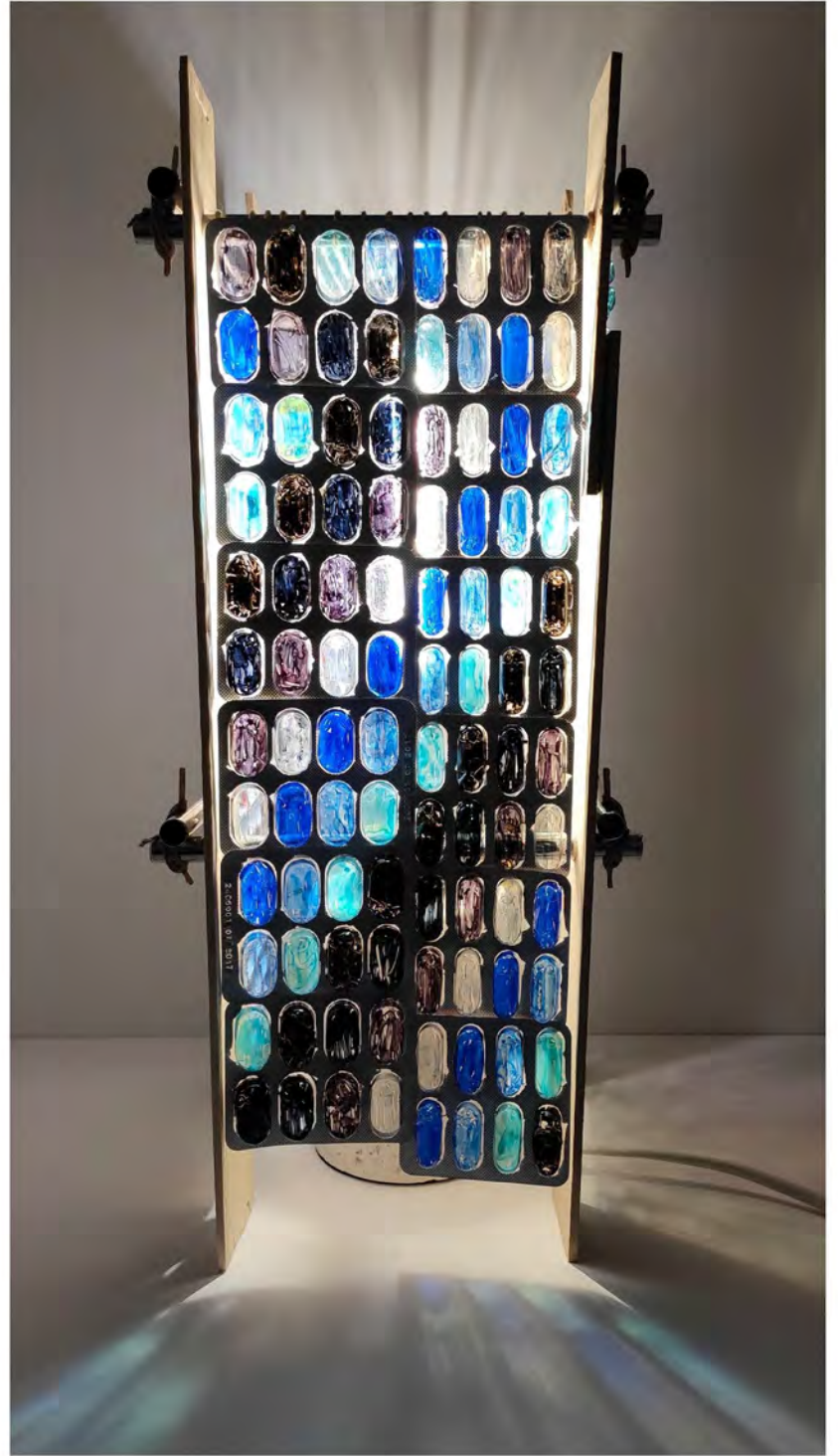

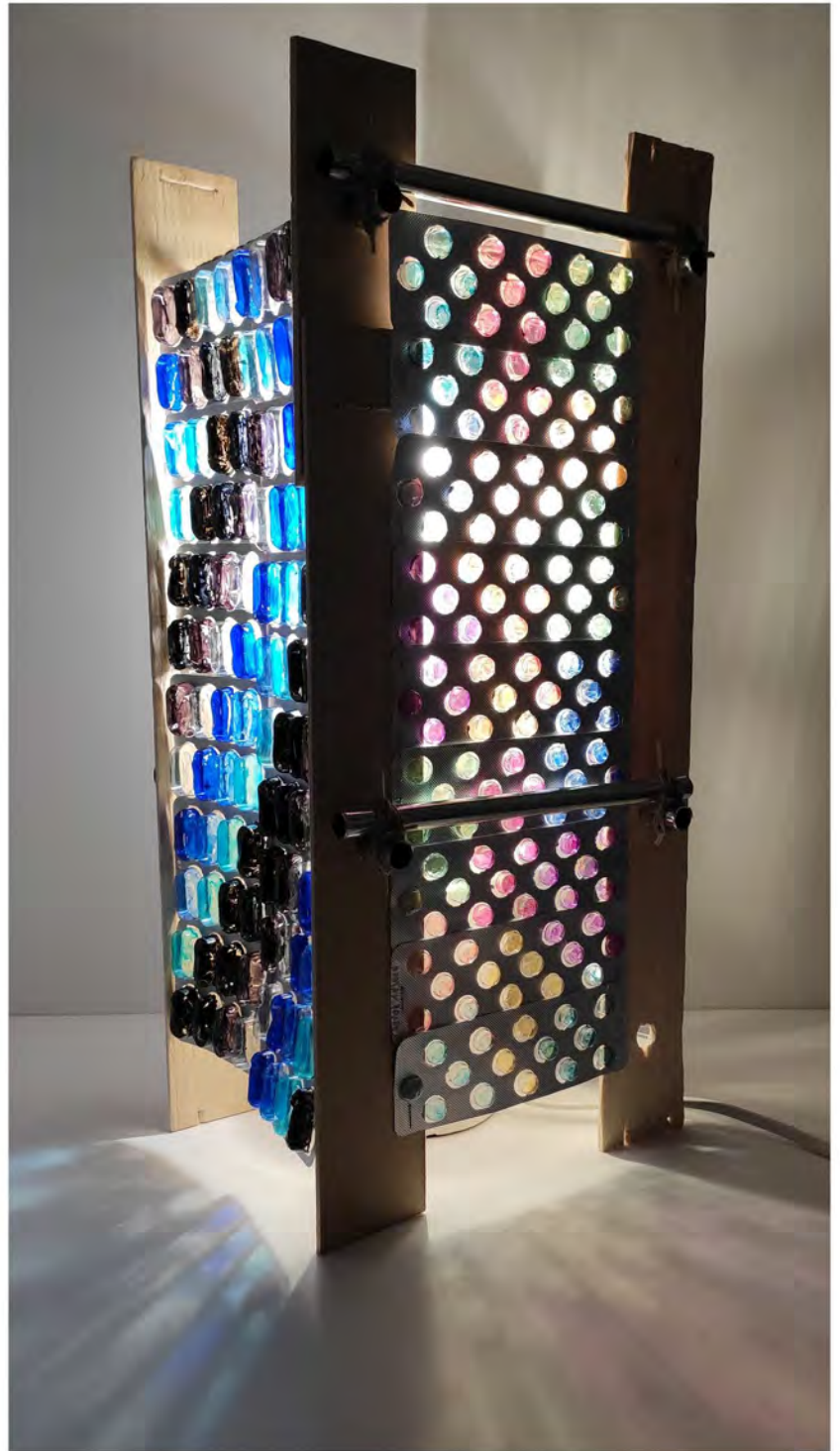
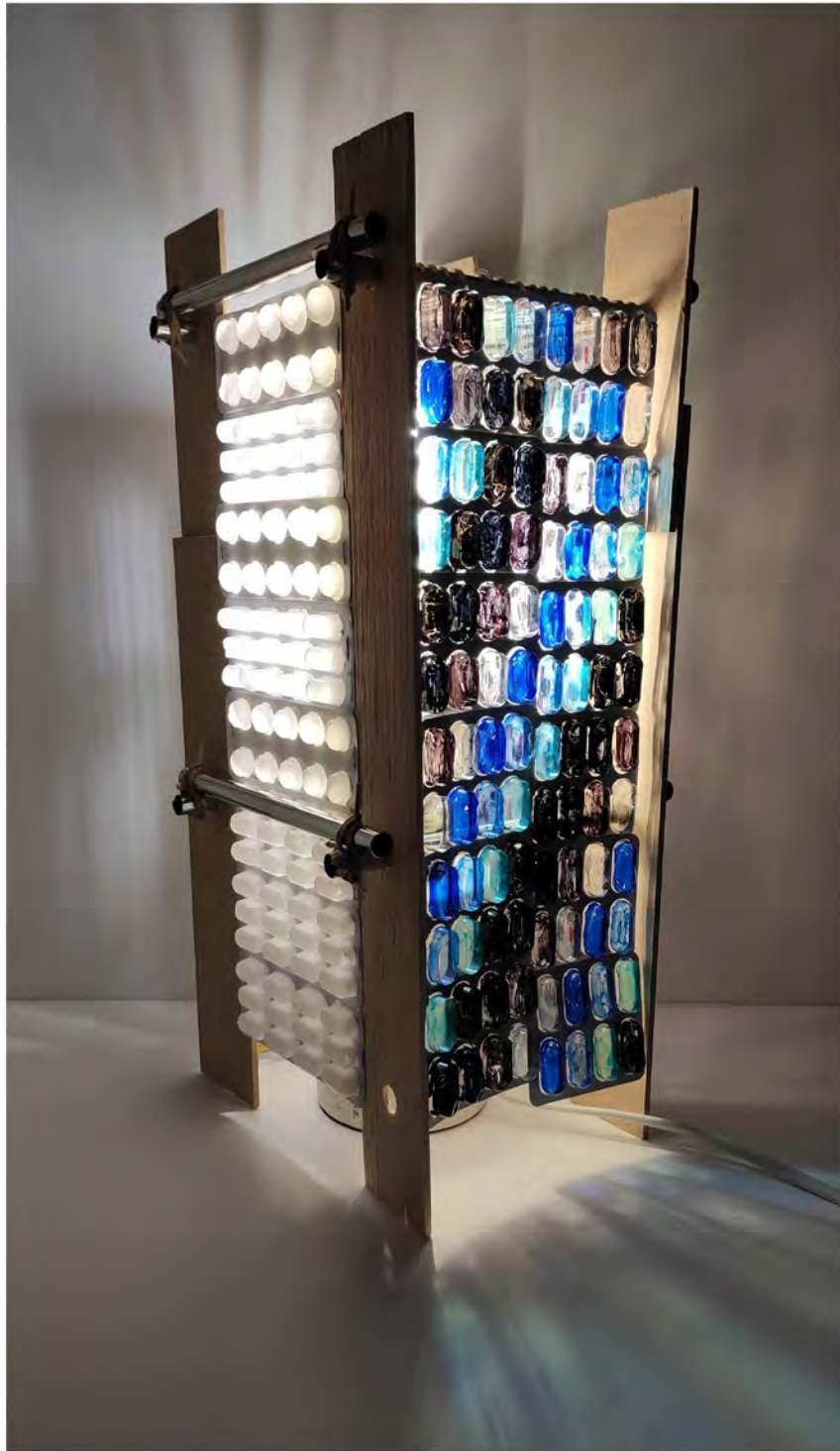



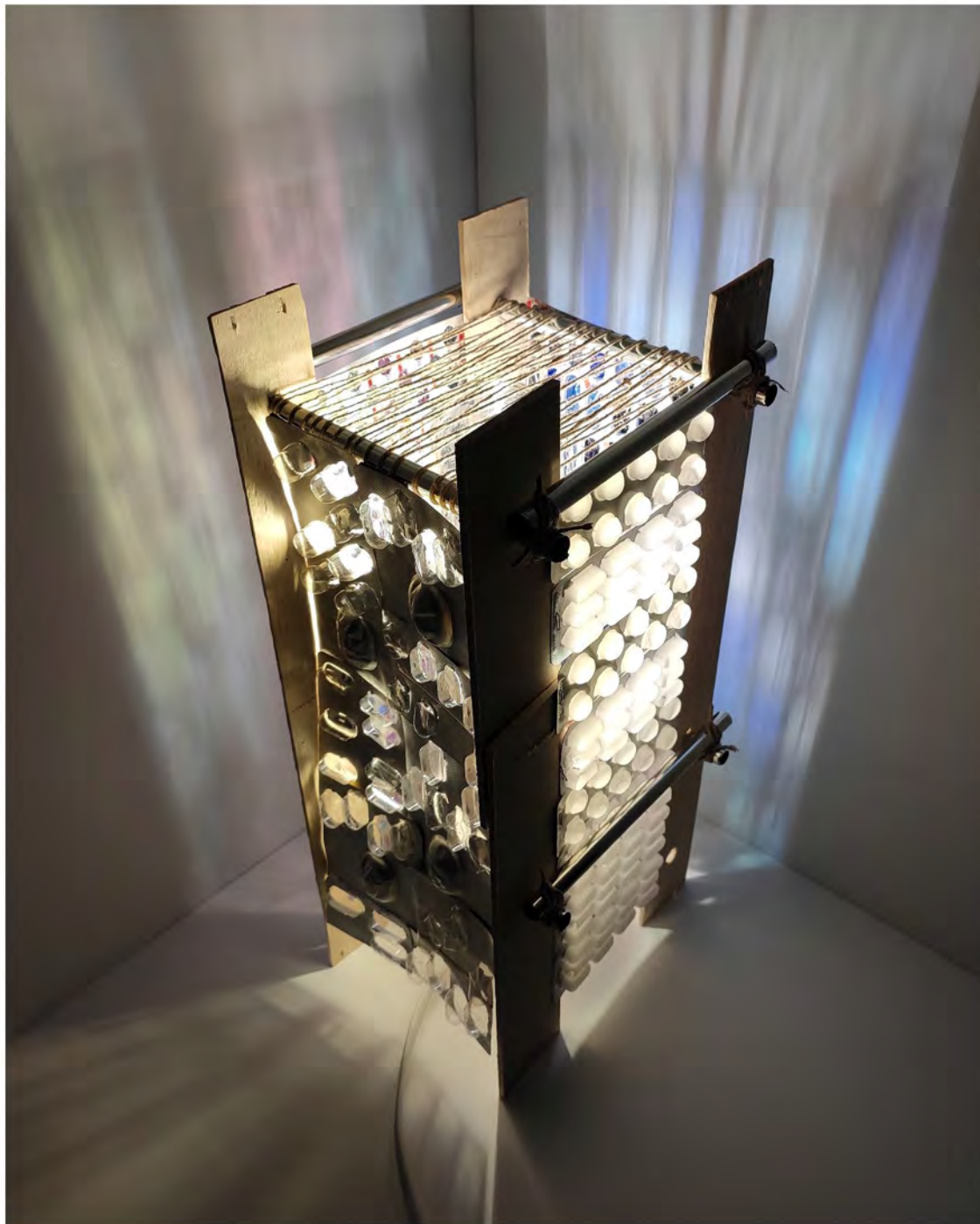

SUPPORT DE PLANTE



MATÉRIAUX ISSUS DES CHUTES DES PRÉCEDENTS OBJETS ET DU GISEMENT INITIALE



- Chutes de carton bois
- Chute de polystyrène
- Tasseau de bois issues du tabouret
- 2 Tubes aluminium
- Baguette chinoise
- Moule en aluminium

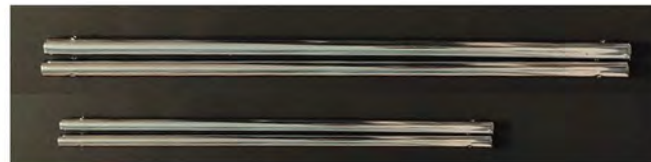

CROQUIS DE CONCEPTION

SUPPORT DE PLANTE :

- RÉTRACTABLE
- ADAPTABLE

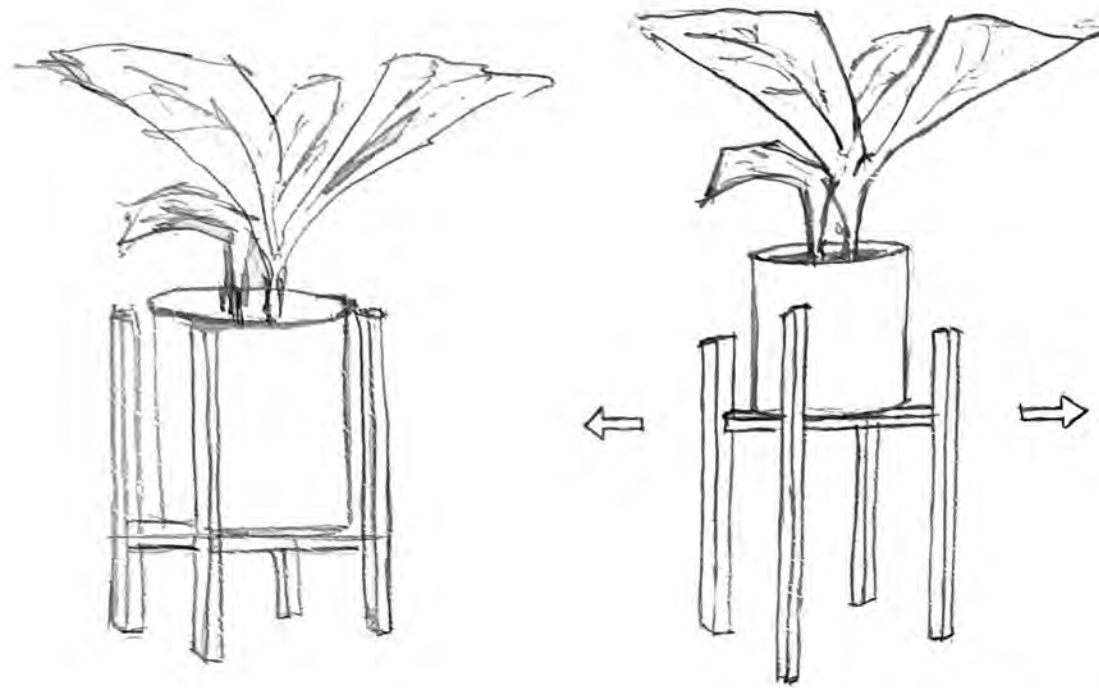

PHASE DE RECHERCHES - CONCEPTION AVEC DU CARTON BOIS

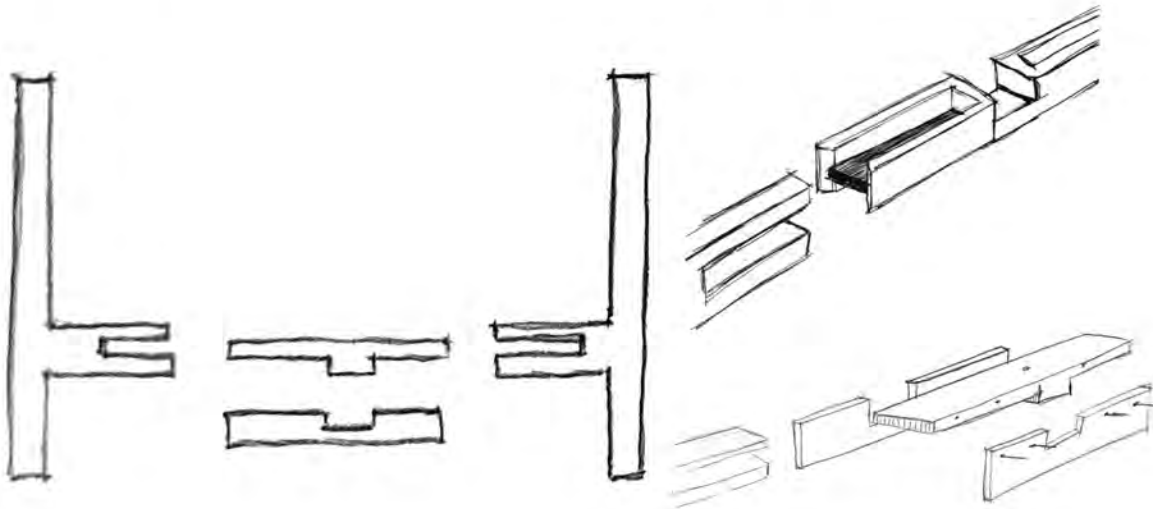

PHASE DE RECHERCHES - CONCEPTION AVEC DES TASSEUX DE BOIS ET LES TUBES EN ALUMINIUM

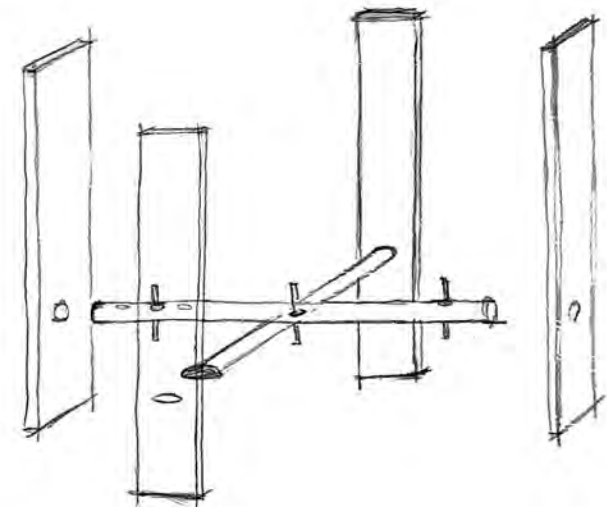

CROQUIS DE CONCEPTION

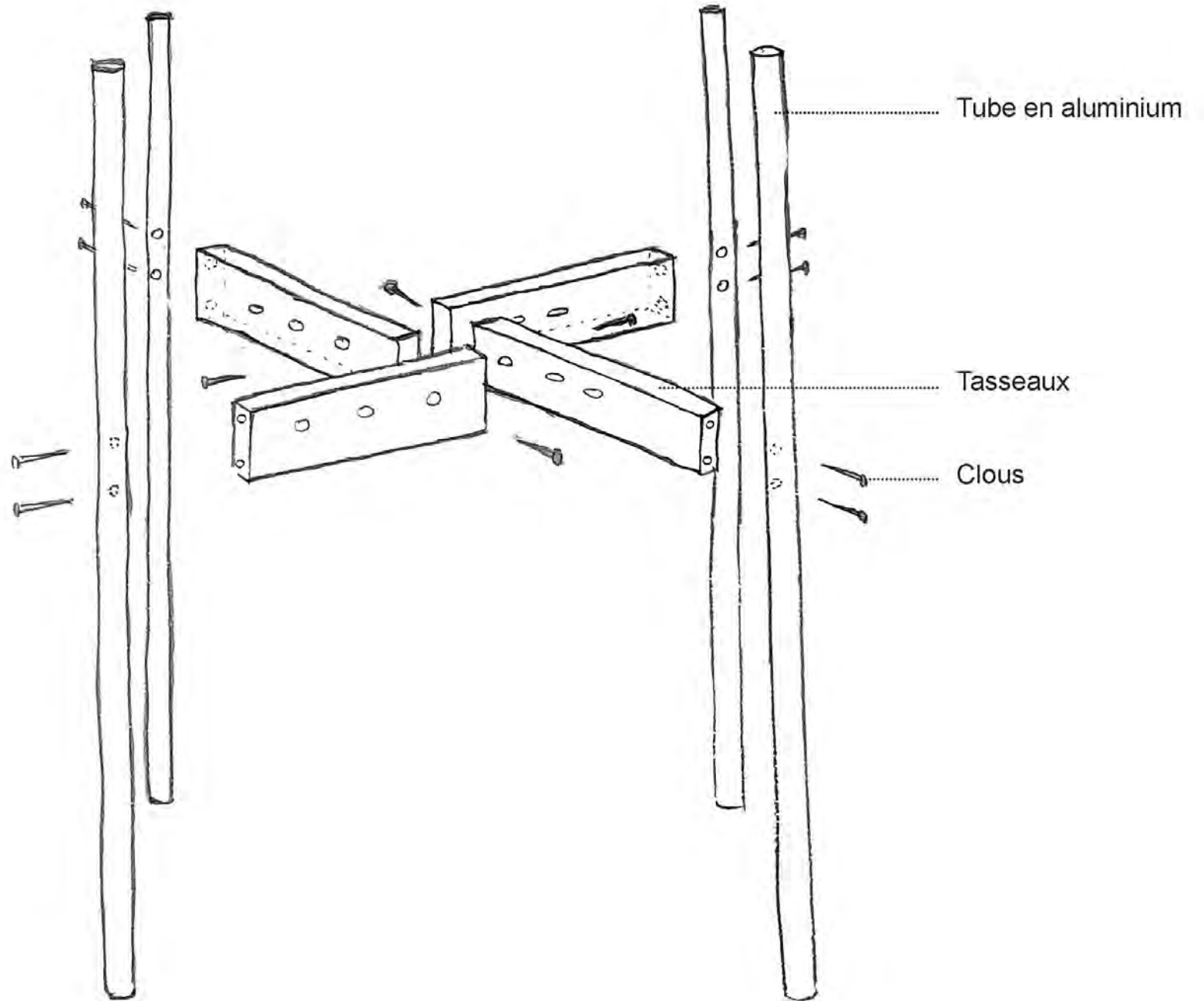
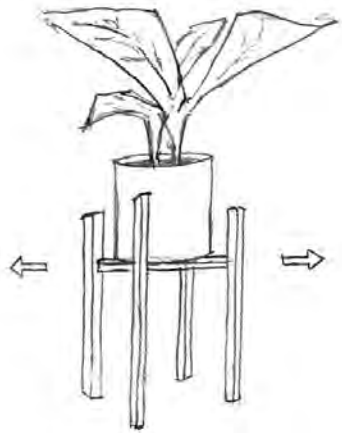

MODULARITÉ DE L'ASSEMBLAGE

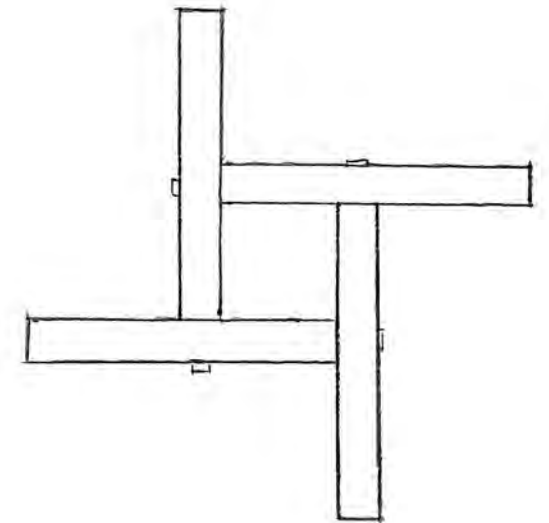
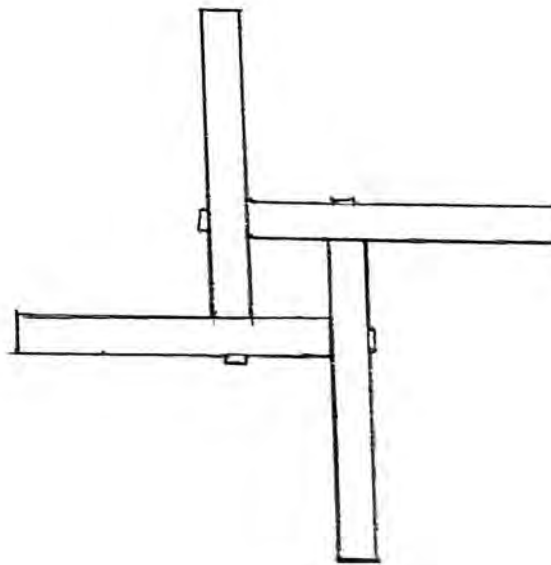
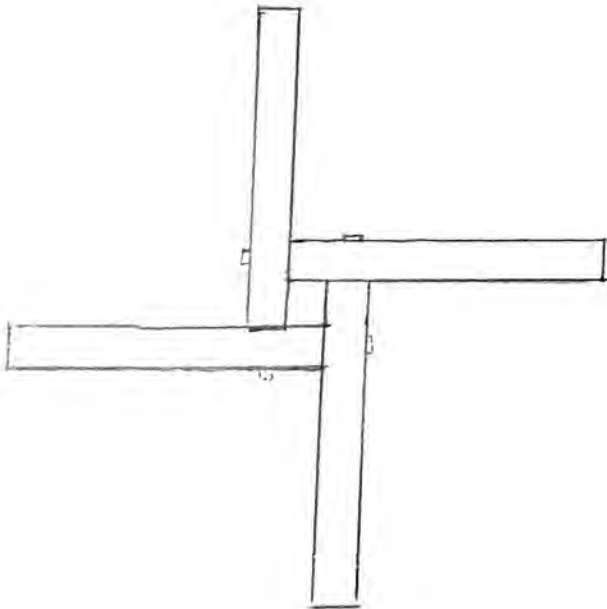
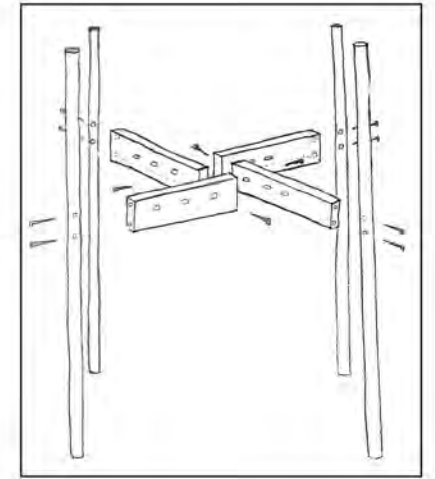
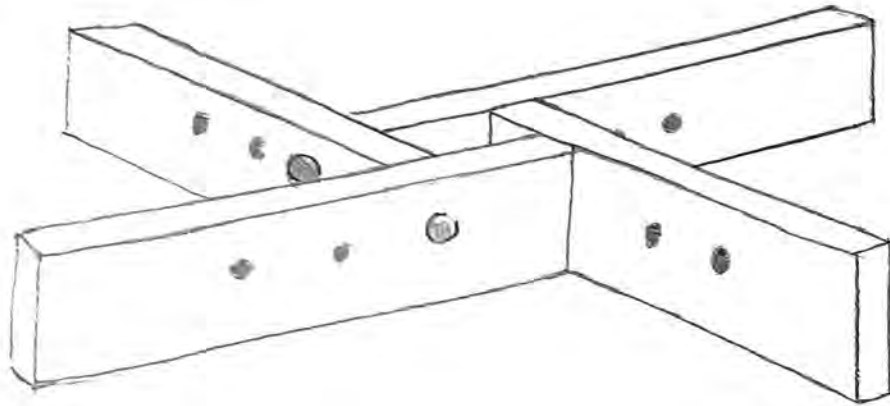

Plus le carré au centre est petit, plus le diamètre est grand

PHOTOS DES PIÈCES



- 4 Tasseaux perforés
- 4 Tube en aluminium
- 8 Clous avec tête
- 4 Clous sans tête



PHOTOS DE L'ASSEMBLAGE



PHOTOS DES DÉTAILS DE L'ASSEMBLAGE

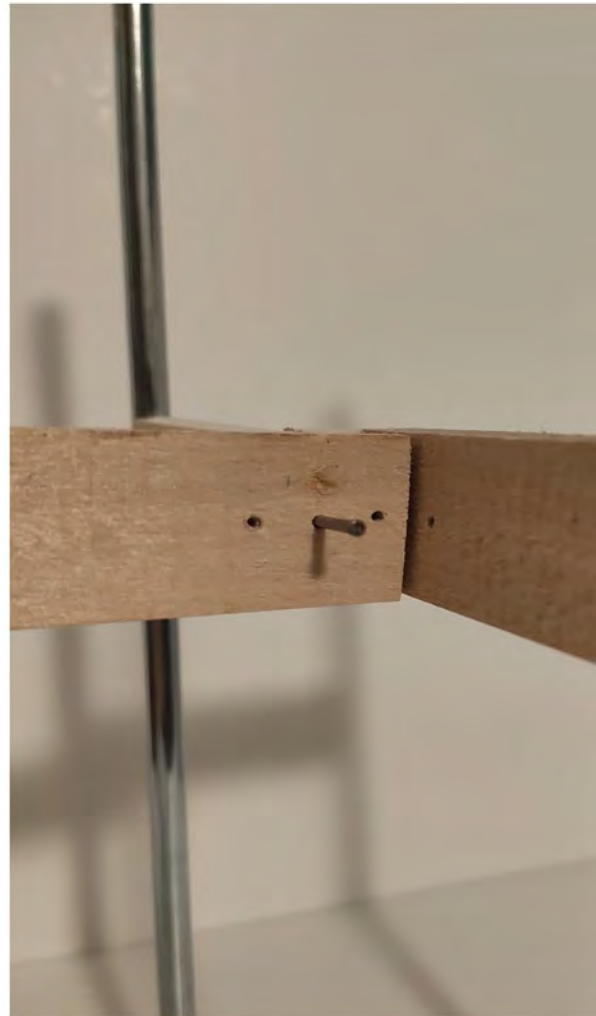
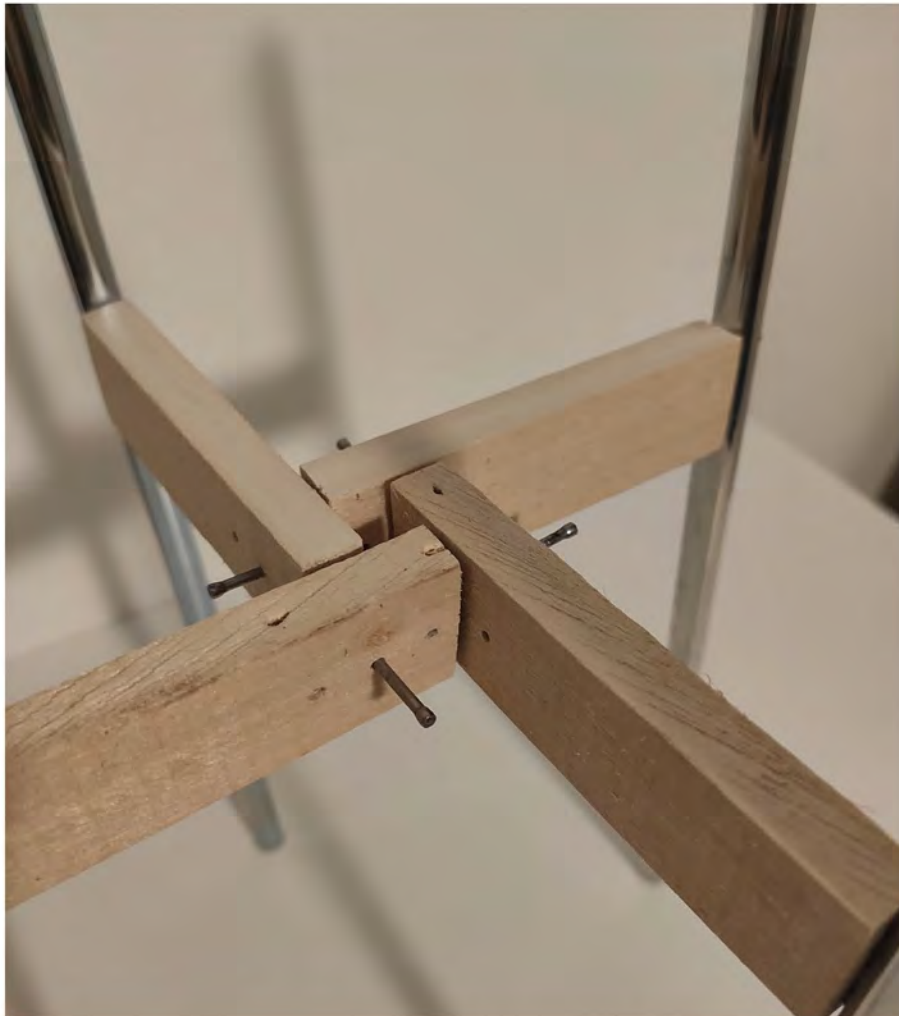
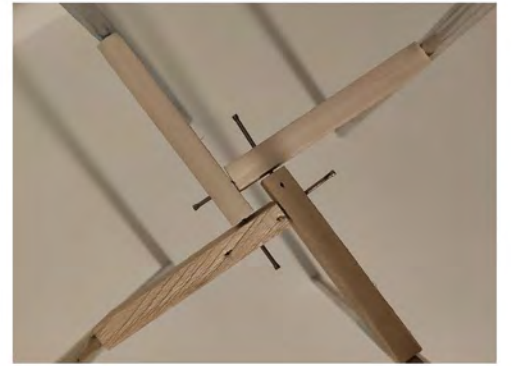

PHOTOS MODULARITÉ DU CARRÉ

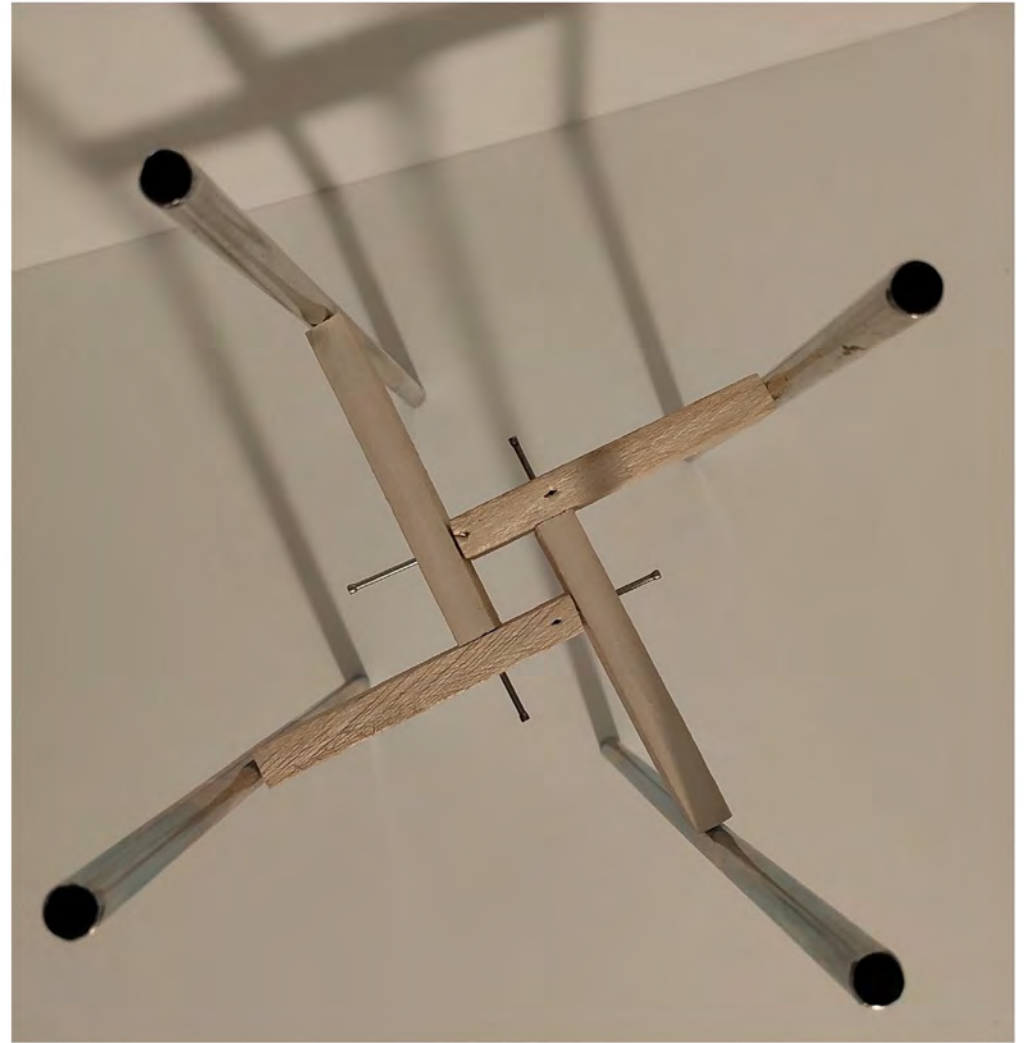
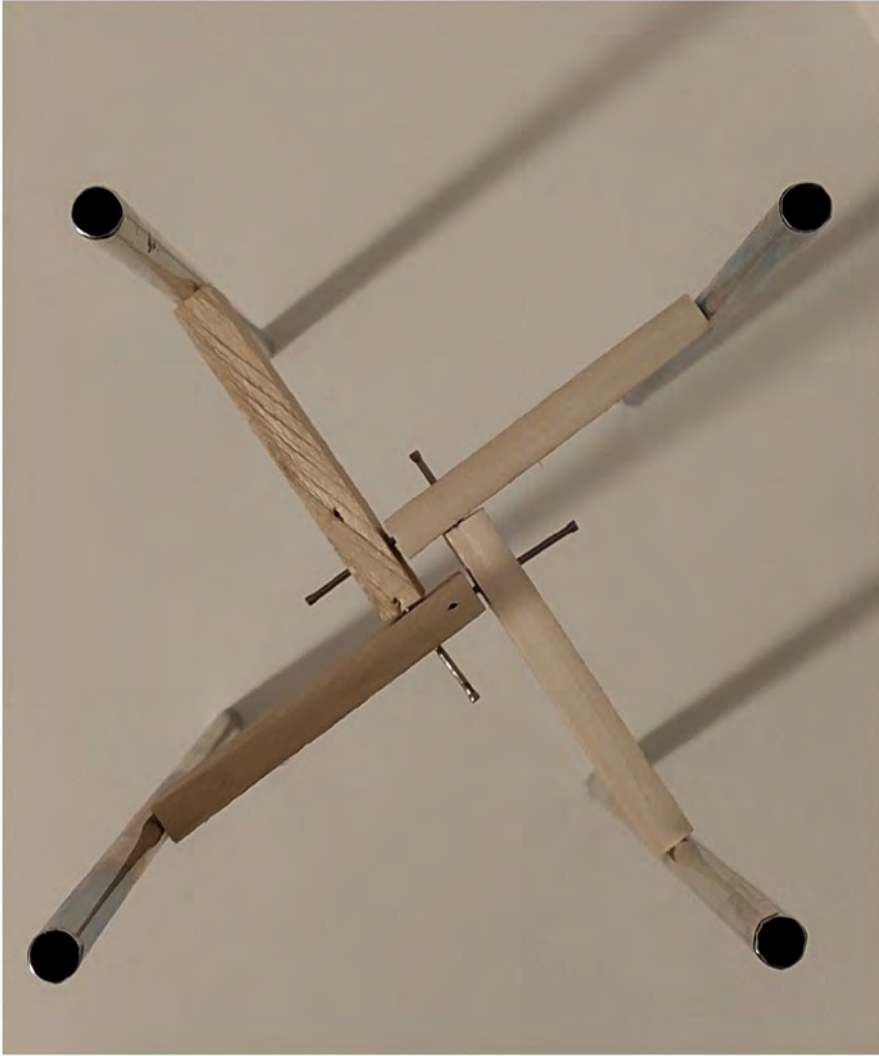

PHOTOS TEST A LA RÉSISTANCE



PHOTOS DE L'ASSEMBLAGE TERMINÉ



PHOTOS EN UTILISATION

