

Analyse par le plan

Général, organisation

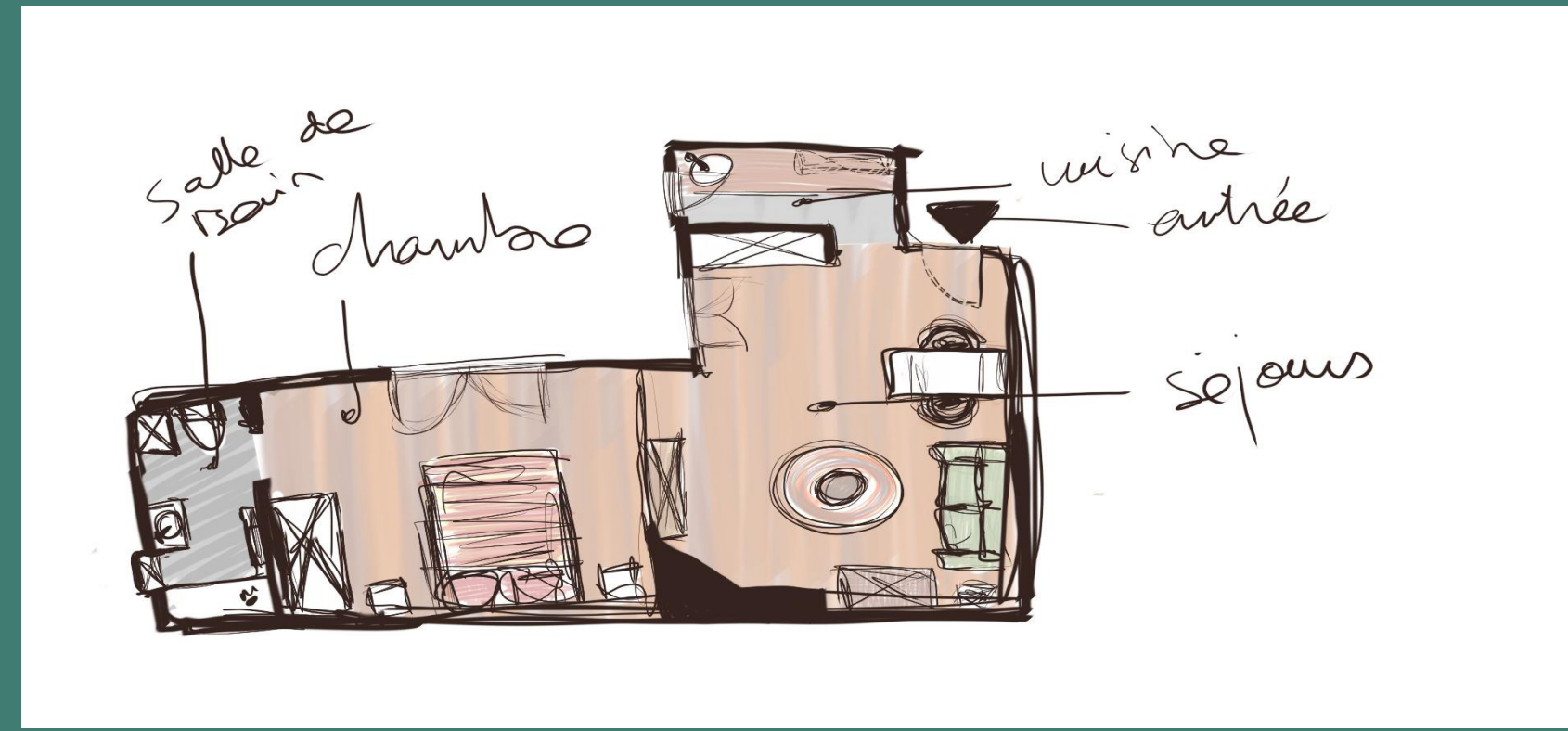

Dimensions

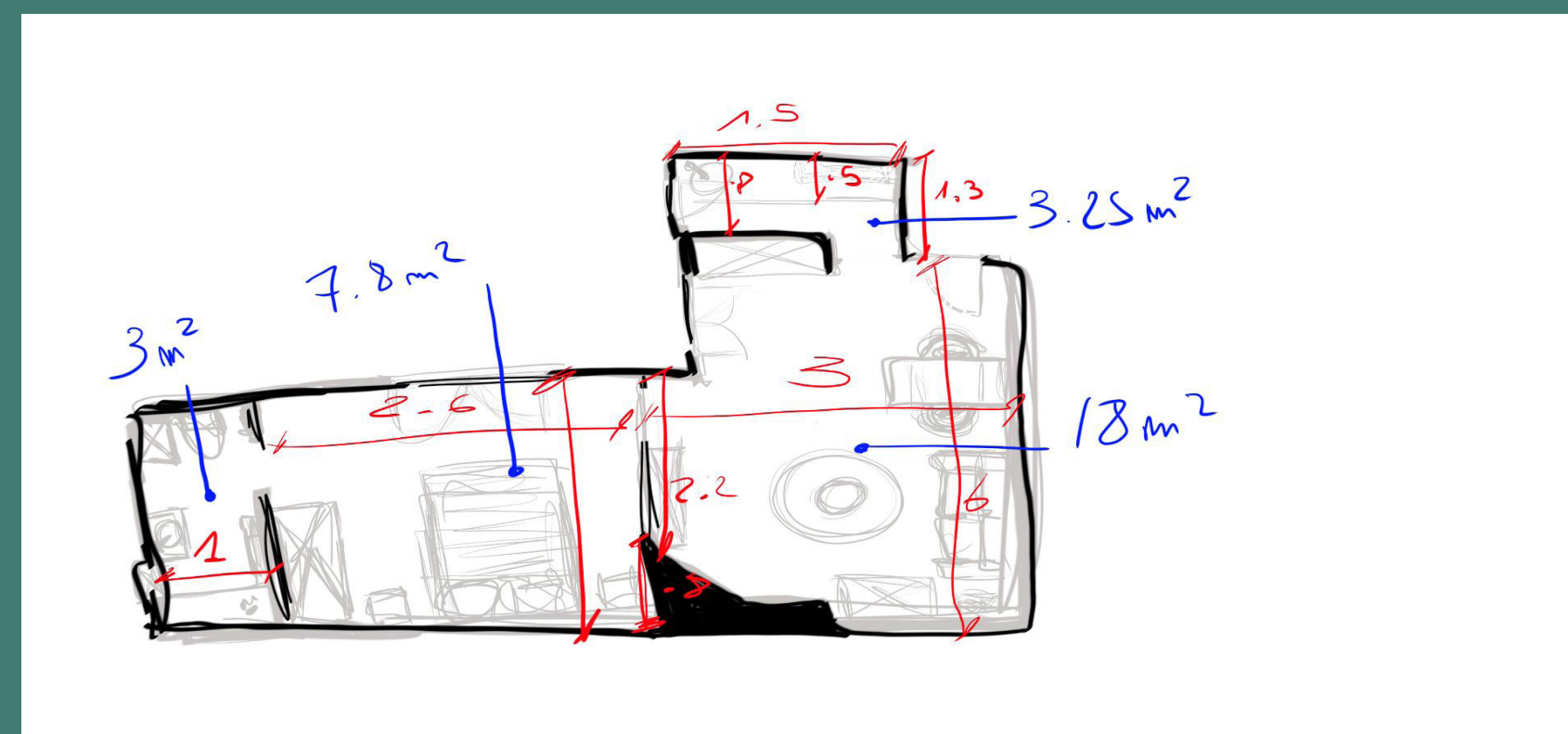

Fonctions

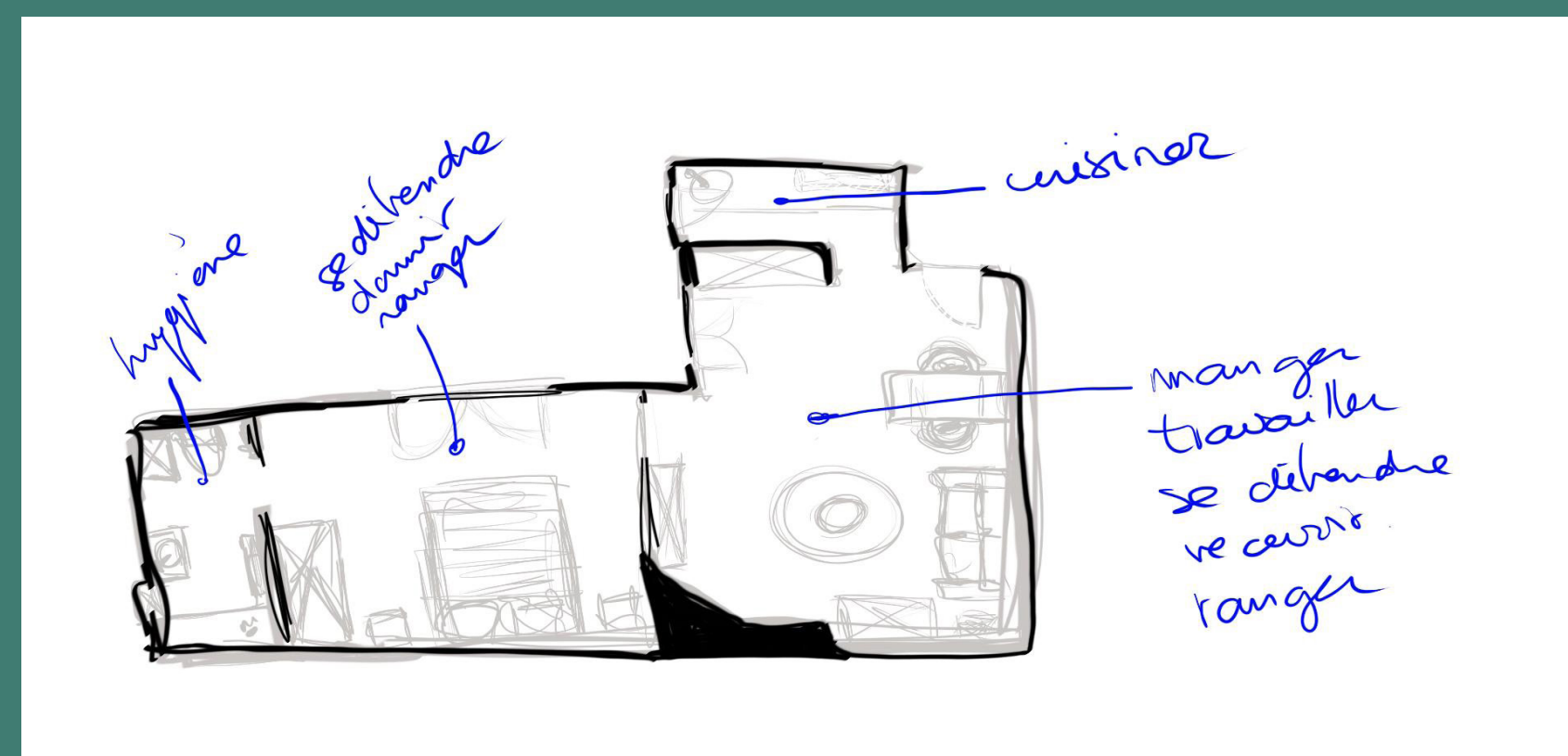

Circulation de l'air

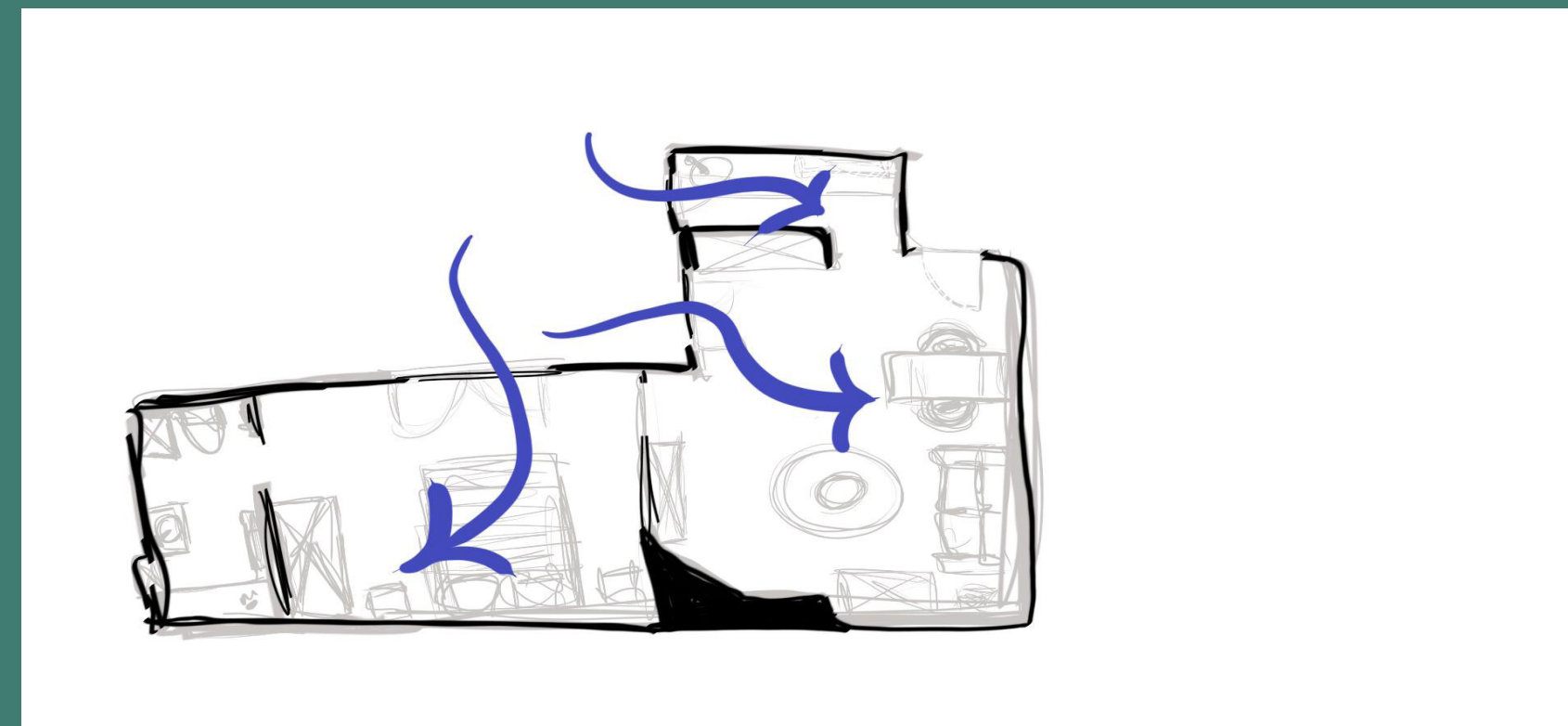

Exposition, apport de soleil

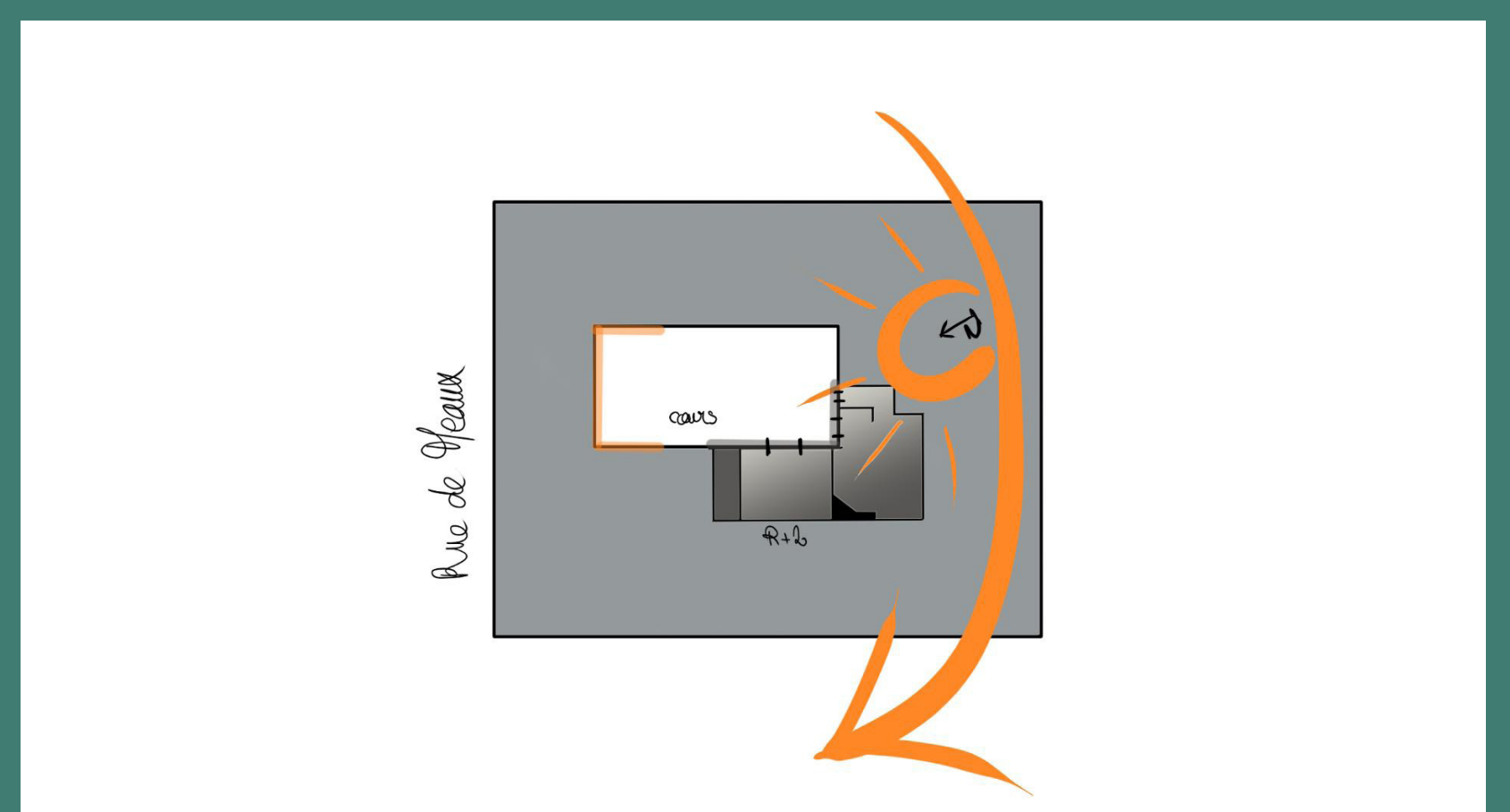

Références

Fujiwara Muro Architects
Osaka 2017



Nuclear submarine



Hong-Kong, Benny Lan

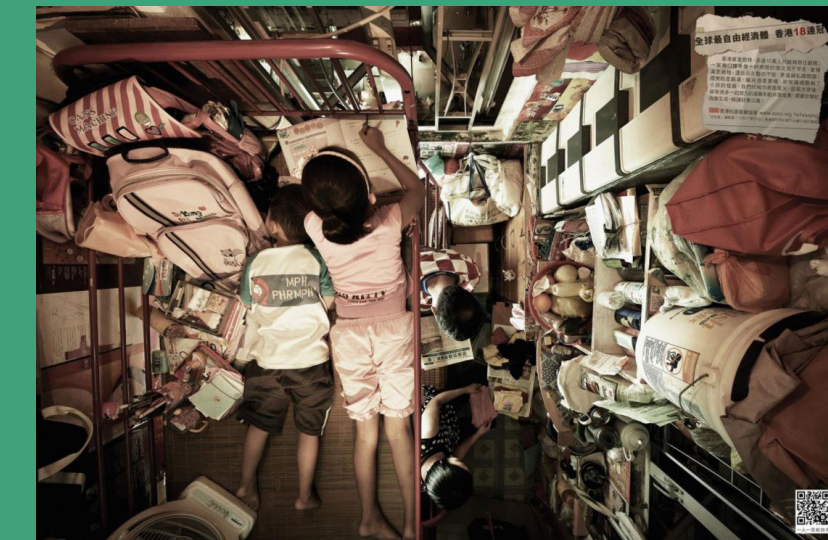

Capsules parasites,
Jean-Louis Chanéac



MOLO

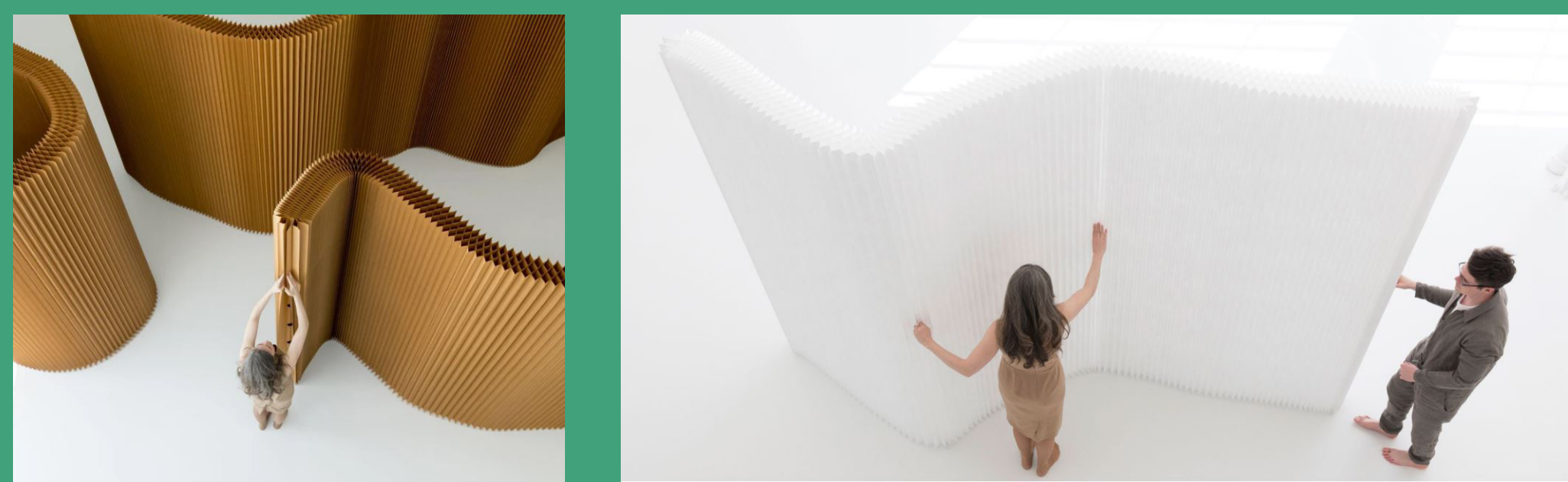

Christian Pottgiesser
bureaux, Paris

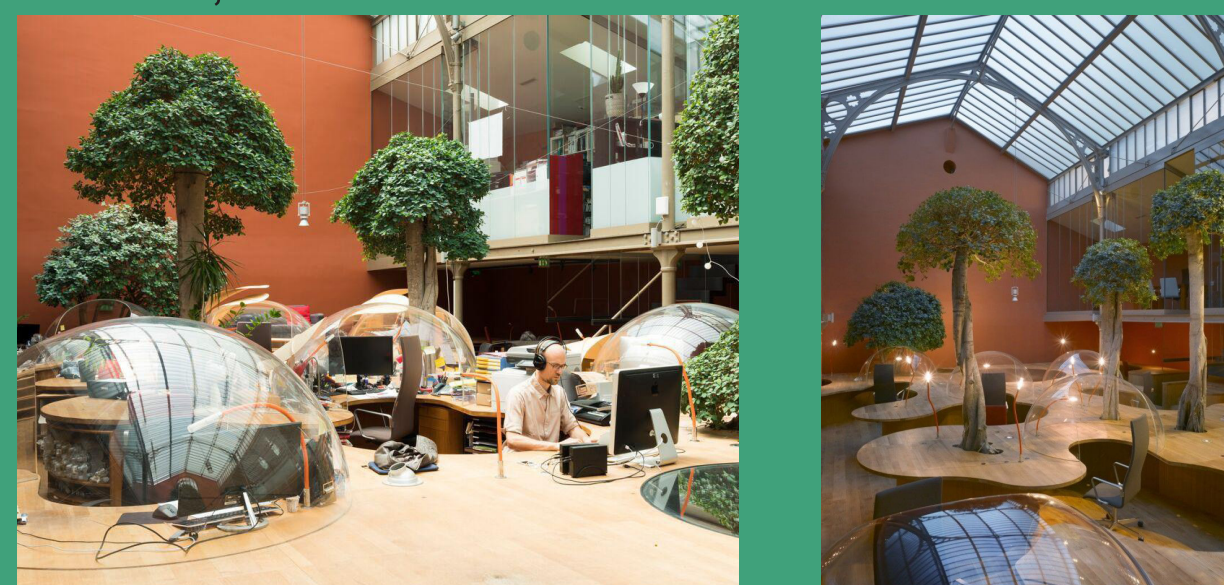

Morning Routine



GLOBAL

Vis à vis

HSP

Creux

Porosités

E
N
T
R
E
E



S
E
J
O
U
R



C
U
I
S
I
N
E



C
H
A
M
B
R
E



S
D
B

