

TRANSAGRITY

M.U.C
MEUBLES ET CORDES

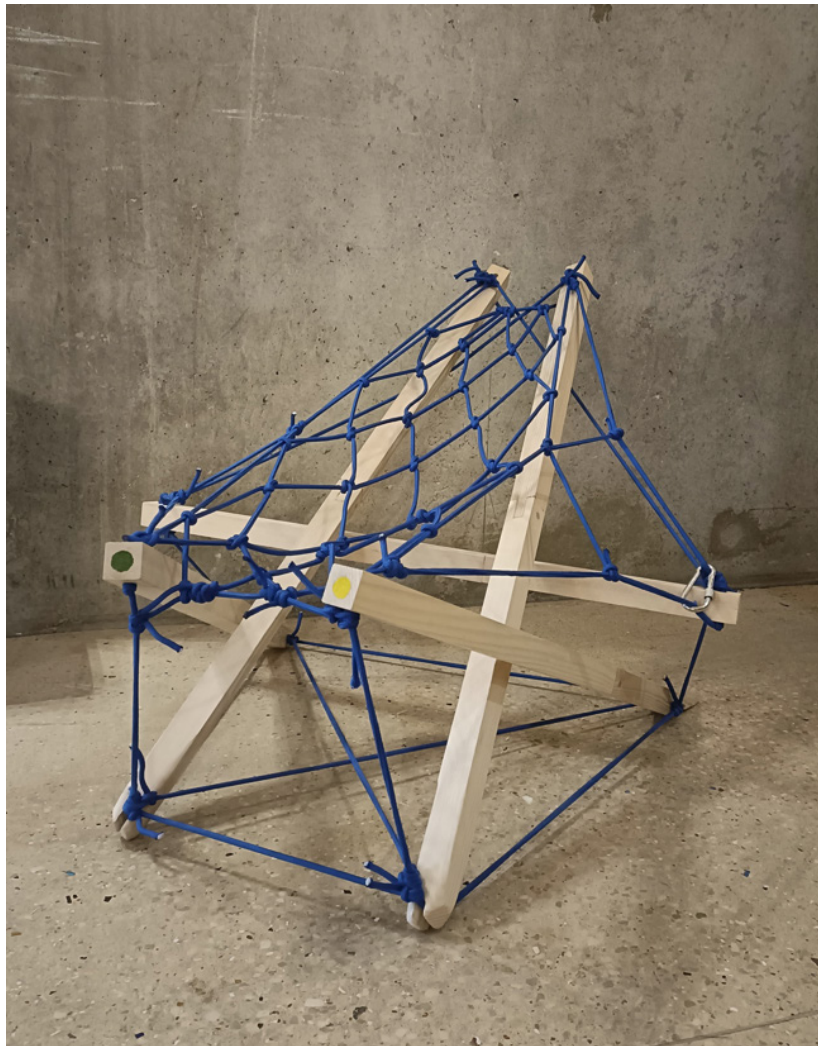

MARIANNE CAUDRON - USMANN MALIK - CLARA RUBIO GAFSI

Ecole Nationale Supérieure d'Architecture Paris - Malaquais



ATTENTION!

WARNING!

¡ATENCIÓN!

Cette chaise **n'est pas** une balançoire. Gardez les pieds au sol au risque d'une chute grave.

This chair **is not** a swing. Keep your feet on the ground.

Esta silla **no** es un columpio. Mantenga los pies en el suelo.

Asseyez-vous en douceur.

Sit down gently.

Siéntese con cuidado.

A transporter avec prudence. La corde peut s'emmeler et entraîner la chute.

Carry with caution. The rope can get entangled and drag you down.

Transportar con cuidado. La cuerda puede enredarse y causar caídas.

M.U.C - MEUBLES ET CORDES

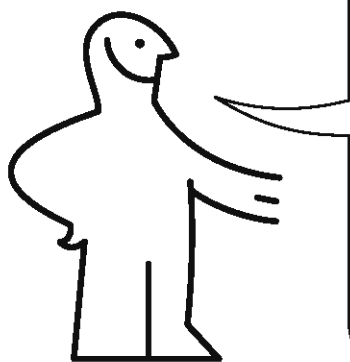

Huile de coude

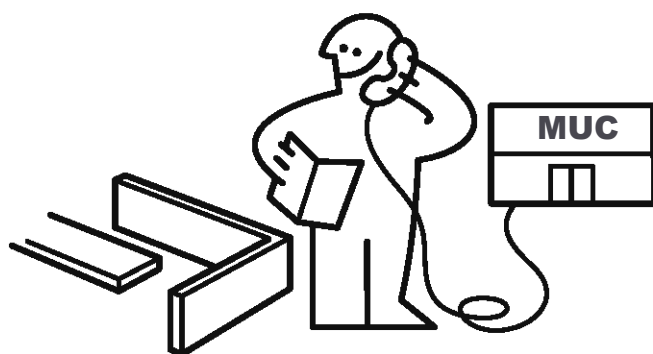
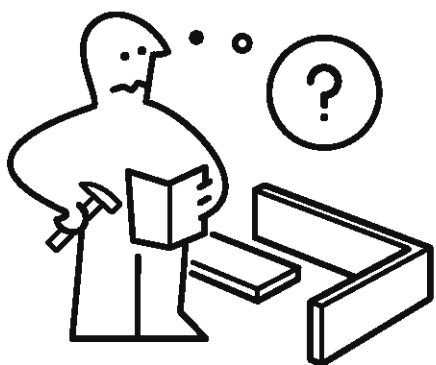
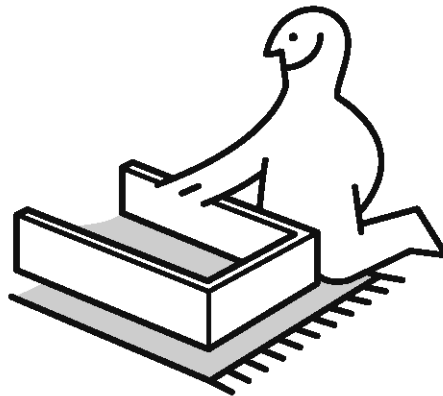
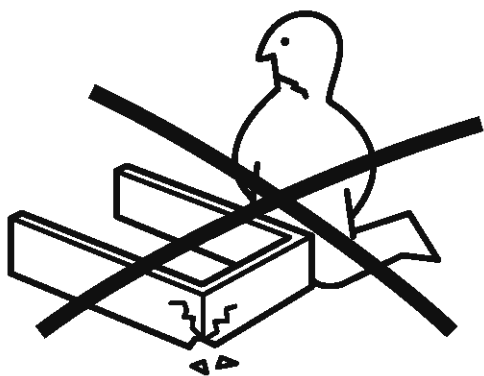
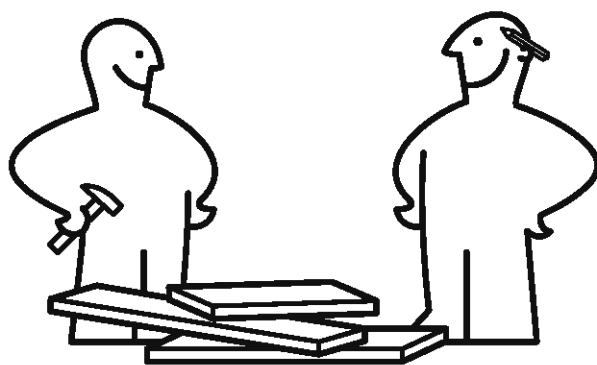

INVENTAIRE



x1
90 cm

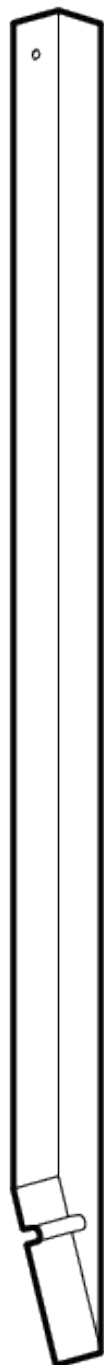

x2
90 cm



x2
110 cm

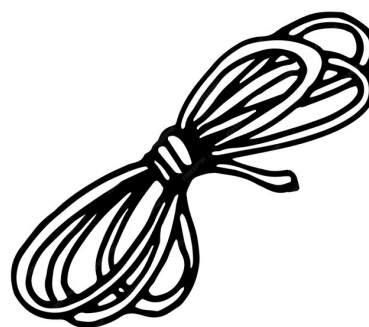

Corde Escalade

NOTICE DE MONTAGE

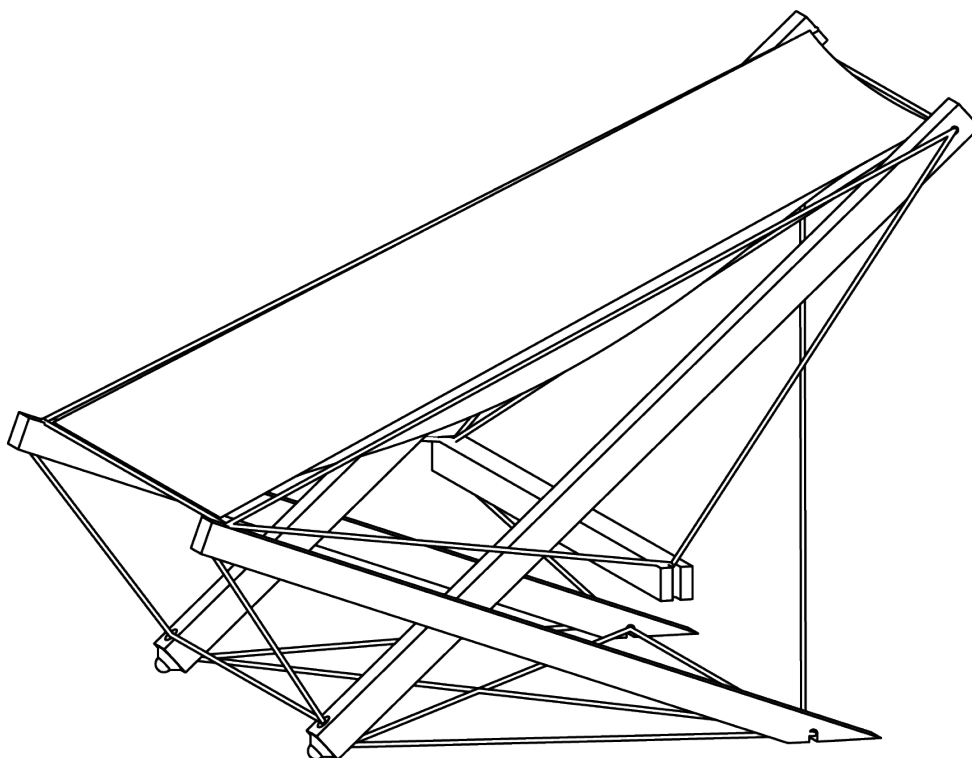

1

2

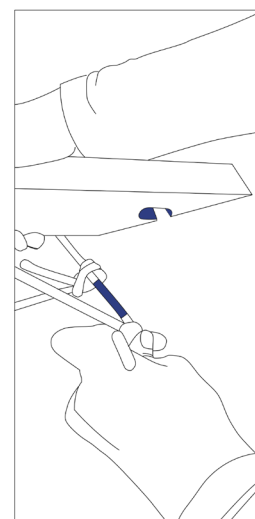
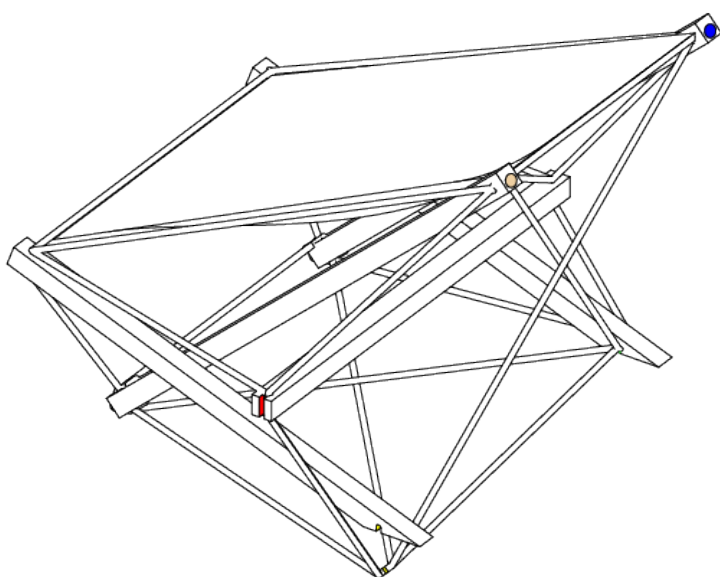

x 5



NOTICE DE MONTAGE

3

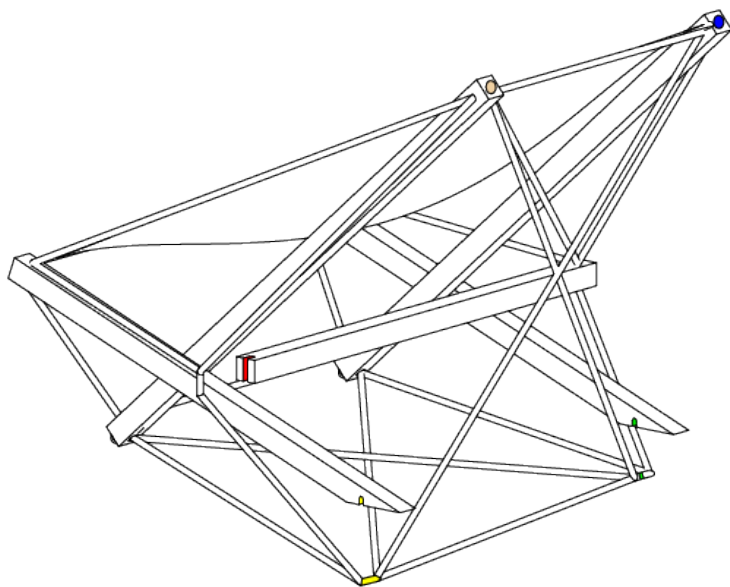

4

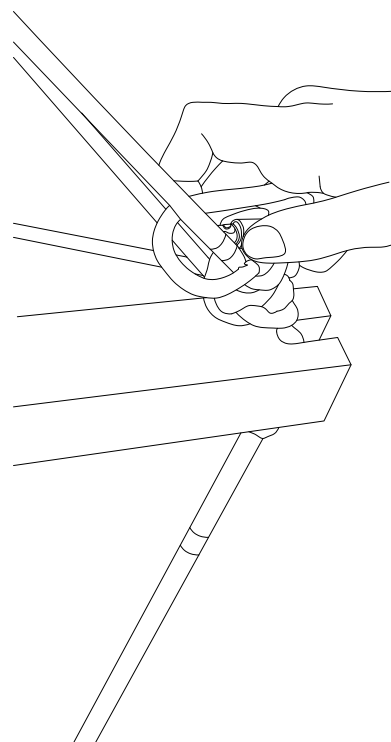
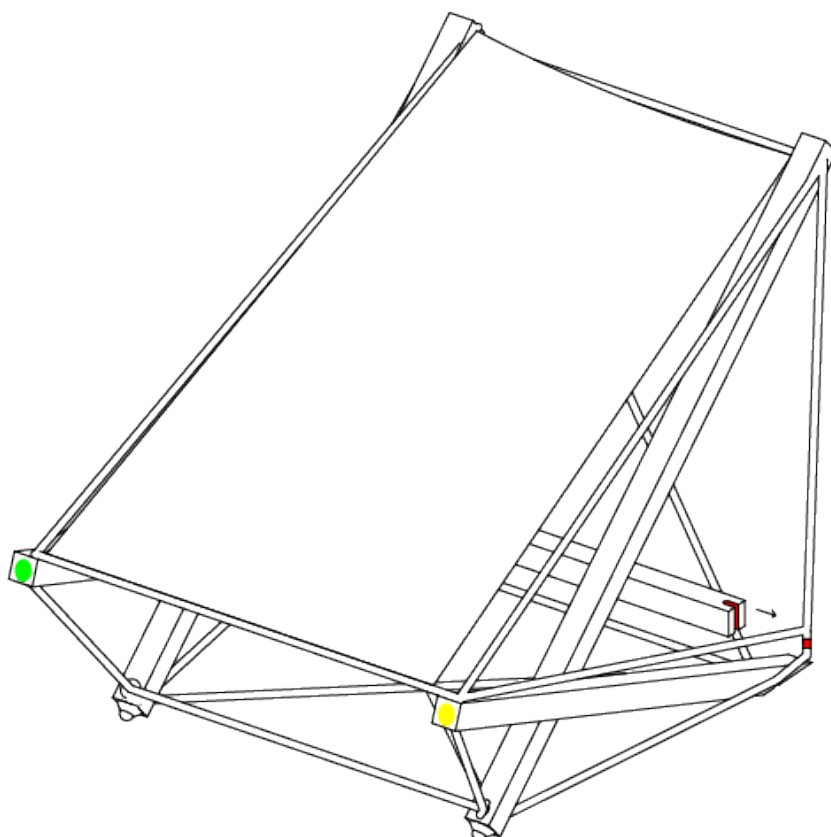

Maquette d'essai

